



PRODUCT PACKAGING STANDARDS



GUIDELINES FOR CHEMICAL ANALYSIS



PRODUCT PACKAGING STANDARDS

Shipping Container Markings
Shipping Container Codes
Shipping Container Design Specifications
Trailers and Inter-Modal Containers
Consumer Unit Labelling Requirements
Standards for Tamper-Evident Packaging

QUALITY ASSURANCE LABORATORY

Guidelines for Chemical Analysis

Prepared by: Quality Assurance Department

Logistics & QA Division
Toronto, Ontario, Canada

Published – March, 1998

Revision Date – February 21, 2013 (see page 60 for a Summary of Document Revisions)

TABLE OF CONTENTS

1. Shipping Container Markings

1.1	General Information	6
1.2	Print Contrast Standard (PCS).....	6
1.3	Dot Matrix or Ink Jet Printing.....	7
1.4	Description of Product on Shipping Containers	11
1.5	LCBO Number (formerly CSPC)	11

2. Shipping Container Codes (SCC-14)

2.1	General Information	13
2.2	Symbol Format	13
2.3	Acceptable Bar Code Formats.....	14
2.4	Symbol Size, Location and Human Readable Characters.....	15
2.5	Standards for Scannability.....	15

3. Shipping Container Design Specifications

3.1	General Information	17
3.2	Wooden Cartons (Vintages Products Only)	17
3.3	Corrugated Fibreboard Cartons	18
3.4	Die Cut Handles.....	19
3.5	Corrugated Fibreboard Trays.....	22
3.6	Shrink Wrap for Corrugated Fibreboard Trays.....	24
3.7	Cans and PET Shipped in Trays	24
3.8	Glass Bottles Shipped in Trays.....	24
3.9	Multi-Pack Consumer Unit	24
3.10	Facings and Corrugating Mediums	25
3.11	Folds and Joints.....	26
3.12	Perforations and Zippers	26
3.13	Bottle Partitions & Head Space	26

4. Trailers and Inter- Modal Containers

4.1	Trailers and Inter - Modal Containers	29
4.2	Loads Shipped In Trailers (Continental N.A. Highway Product)	29

4.3	Loads Shipped In Inter - Modal Containers (Non-Continental N.A. Product).....	30
4.4	Phytosanitary Requirements.....	33
4.5	Protective Services (Temperature Controlled Containers).....	33
4.6	Pull Force Test Method for Measurement of Static Coefficient of Friction.....	34

5. Consumer Unit Labelling Requirements

5.1	General Information.....	38
5.2	Allergen Alert.....	40
5.3	Nutritional Labelling & Claims.....	41
5.4	Gift Basket, Ornamental Containers Accessory Items and Other Labelling Requirements.....	41
5.5	Definitions.....	42
5.6	Product Date Coding.....	43
5.7	LCBO Number (formerly CSPC).....	44
5.8	U.P.C./EAN on Consumer Unit.....	44
5.9	Placement of U.P.C./EAN on Consumer Unit.....	45

6. Standards for Tamper-Evident Packaging

6.1	Intent.....	49
6.2	Definitions.....	49
6.3	Kinds of Tampering.....	49
6.4	Acceptable Types of Tamper-Evident Packaging.....	49

7. Quality Assurance Guidelines for Chemical Analysis

7.1	Chemical Testing Guidelines.....	51
-----	----------------------------------	----

Appendices

Appendix A:	ANSI Print Quality Guidelines.....	57
Appendix B:	Terms and Definitions.....	59

Summary of Document Revisions

Summary of Document Revisions.....	60
------------------------------------	----

INTRODUCTION

The *LCBO Product Packaging Standards and Guidelines for Chemical Analysis* is a document designed to assist suppliers in ensuring their products will meet minimum requirements for case markings, corrugated fibreboard packaging, trailer/container loading, consumer unit labelling and chemical composition when they arrive at the LCBO.

The document references standards and regulations from a variety of sources including but not limited to: the *Canada Food and Drug Act and Regulations*, the *Canada Consumer Packaging and Labelling Act and Regulations*, the *CFIA Guide to Food Labelling and Advertising*, the *Ontario Liquor License Act and the CALJ - Product Identification Standards for Use in the Distribution of Beverage Alcohol*. While an attempt has been made to include all relevant requirements, space limitations do not allow for every possible requirement to be listed here and suppliers should consult the applicable regulations or standards for situations that are not covered in this document. Ultimately, suppliers are responsible for ensuring their products meet all federal, provincial and LCBO requirements. Failure to conform to these requirements could result in issuing of escalating penalties, fees for corrective work or a product being destroyed or returned to the vendor, all at the vendor's expense. A copy of the fee schedule can be found on the Quality Assurance web pages of the LCBO Trade Resources website: <http://www.doingbusinesswithlcbo.com/>.

This document is updated periodically to reflect changes in federal, provincial or LCBO requirements.

Should you have any questions on the requirements or suggestions for improvements to this document please contact the LCBO Quality Assurance department at:

Telephone: 416-864-6724

Facsimile: 416-864-6841

Email: quality.assurance@lcbo.com

1. SHIPPING CONTAINER MARKINGS

General Information

Print Contrast Standard (PCS)

Dot Matrix or Ink Jet Printing

Description of Product on Shipping Containers

LCBO Number (Formerly CSPC)

1. SHIPPING CONTAINER MARKINGS

1.1 General Information

- 1.1.1 All products purchased by the LCBO must be packaged in shipping containers that are marked in accordance with the requirements set out in this document in addition to any requirements set out in the Canadian Association of Liquor Jurisdictions (CALJ) *Product Identification Standards for Use in the Distribution of Beverage Alcohol*, as amended from time to time. Where discrepancies exist between these two standards, the CALJ standard shall take precedence.
- 1.1.2 Non-compliance may result in rejection of shipments or the levying of a non-compliance penalty. Additionally, suppliers will be charged back for any action taken on behalf of the LCBO to correct shipping container marking deficiencies.
- 1.1.3 Shipping Container Markings **must** be clear and legible, printed in bold typeface, and positioned:
- **in such a manner as not to be confused with other markings, and**
 - **so that they are horizontal to the top and bottom of the stored shipping container.**
- 1.1.4 Shipping Container Markings **shall** be positioned so they can be read when the consumer units packaged inside are placed in an optimum position for **storage**. For example, wine (except sparkling and fortified) sealed with natural cork closures are placed inside shipping containers with the cork facing down or with the consumer units laying on their side, whereas, wine sealed with screw cap closures are placed upright.
- 1.1.5 Shipping Container Markings **must** either be printed or stamped directly onto the corrugated fibreboard shipping containers. Labels are acceptable provided a full contact to surface adhesive is used. Staples are not permitted.
- 1.1.6 Mandatory and optional Shipping Container Markings are detailed in Chart 2. Examples of proper markings are shown in section 1.3.3.
- 1.1.7 Phytosanitary requirements for wooden shipping containers are outlined in Trailer Loads and Inter-Modal Container Section (Section 4.0).

1.2 Print Contrast Standard (PCS)

- 1.2.1 Print contrast is the relationship between the reflectance value of the light colour (R_L) of the corrugate or substrate and the dark colour (R_D) of the printing ink, or visa versa.
- 1.2.2 A verifier with a light wavelength of 670 nm \pm 10 nm is required to determine reflectance values.
- 1.2.3 The following formula is used to determine the Print Contrast Standard (PCS), based on the reflectance values of the light colours (R_L) and dark colours (R_D):

$$PCS = \frac{R_L - R_D}{R_L}$$

- 1.2.4 Locate the percent reflectance value of the light colour (R_L), as determined by the verifier, shown in Chart 1. The minimum percent reflectance of the dark colour (R_D) and the minimum print contrast (PCS) should be equal to or greater than the corresponding values shown on the Chart 1.

CHART 1 – PRINT CONTRAST STANDARDS

Light Colours		Dark Colours		Minimum Print Contrast Standard (PCS)
Percent Reflectance % (R _L)	Density	Percent Reflectance % (R _D)	Minimum Density	
31.6	.500	2.5	1.600	.921
35.0	.456	3.3	1.485	.906
40.0	.398	4.6	1.335	.884
45.0	.347	6.3	1.202	.860
50.0	.301	8.3	1.083	.834
55.0	.260	10.6	0.975	.807
60.0	.222	13.3	0.877	.779
65.0	.187	16.4	0.786	.748
70.0	.155	19.8	0.703	.717
75.0	.125	23.7	0.625	.684
80.0	.097	28.1	0.552	.649
85.0	.071	32.9	0.484	.614
90.0	.046	38.1	0.419	.577
95.0	.022	43.9	0.358	.538
100.0	.000	50.1	0.300	.499

1.3 Dot Matrix or Ink-Jet Printing

- 1.3.1 Dot matrix and ink-jet are acceptable formats for printing markings onto corrugated fibreboard shipping containers.
- 1.3.2 Letter quality printing is required for both formats. Depending on the required print height, letter quality print should be achieved if the following settings are used:

Minimum Print Height Requirements	Font Size	Pitch	Dots per Inch
1.00 inch or 2.54 cm	72 pts	1.5 cpi	360 dpi
0.50 inch or 1.27 cm	36 pts	3.0 cpi	360 dpi

1.3.3 Shipping Container Markings

(Example drawings below – see Chart 2 for full requirements)

A) Product sealed with a cork closure and stored in an inverted position.

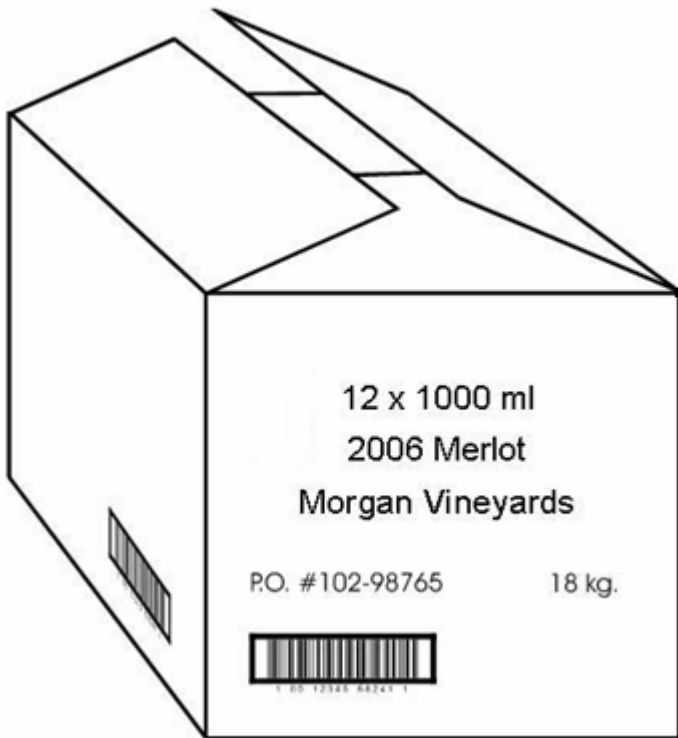
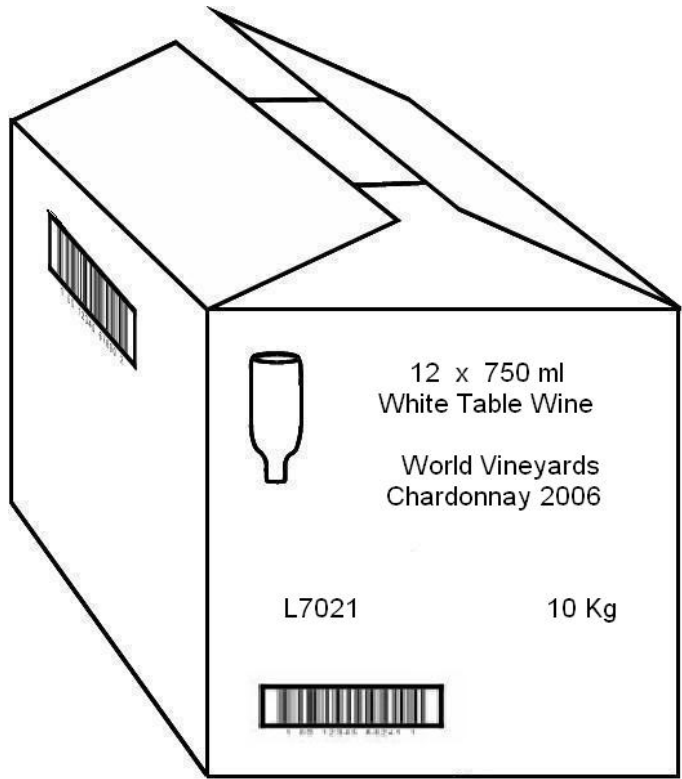

B) Product stored in an upright position.

CHART 2 – SHIPPING CONTAINER MARKINGS

MARKINGS	LOCATION	MIN HEIGHT	PRINT	OTHER SPECIFICATIONS
(1) Shipping Container Code	On one end panel and an adjacent side panel.			Exact size, placement and format is determined by the bar code symbol used, e.g., Interleaved 2 of 5 or UCC/EAN 128. See SCC-14 Specifications. For additional information, refer to the Canadian Association of Liquor Jurisdictions <i>Product Identification Standards for Use in the Distribution of Beverage Alcohol</i> .
	Position anywhere along the length of the panel, not less than 3.18 cm (1.25") from the bottom of shipping container and not less than 1.91 cm (0.75"), excluding quiet zone, from any vertical edge.			
Human Readable Characters	Human readable numerical characters are required.	0.51 cm (0.20")	San Serif Font	<i>Note: a unique SCC is required for each U.P.C./EAN.</i>
(2) Product Date Code as: Purchase Order Number OR Production Date OR Lot Number/ Batch Number OR	Cartons: On same side panel or same end panel as shipping container code. Trays: Optional ²	1.27 cm (0.5")	Bold	The Purchase Order Number must be distinctly separate from any other coding. e.g., P.O. # 102-54321 <i>Note: A Production Date, Best Before, Lot Number or Batch Number may be used instead.</i>
	Cartons: On same side panel or same end panel as shipping container code. Trays: Optional ²	1.27 cm (0.5")	Bold	Express the date in one of the following ways: <ul style="list-style-type: none"> • month/day/year, in an alpha format expressed as January 21, 2007, or in an alpha-numeric format expressed as A/21/2007 or A/21/2007. • dd/mm/yyyy, in numeric or alpha-numeric format, (e.g., 21/01/2007 or 21/A/2007). • yyyy/mm/dd, in numeric or alpha-numeric format, (e.g., 2007/01/21 or 2007/A/21). <i>Note: The letter I is omitted from the alpha-numeric format. A space, back-slash or hyphen may be used to separate the dd/mm/yyyy or yyyy/mm/dd.</i> <ul style="list-style-type: none"> • y/jjj, where "y" is the year and "jjj" is the Julian calendar day, (e.g., 7021). The Production Date must be separated from any other coding by a distinct space.
	Cartons: On same side panel or same end panel as shipping container code. Trays: Optional ²	1.27 cm (0.5")	Bold	The Lot Number, e.g., L7021M , is expressed as follows: <ul style="list-style-type: none"> L = Lot Number 7 = Year (2007) 021 = Julian calendar (21st day) M = Production plant The Lot Number must be distinctly separate from any other coding.

Note: Chart 2 is continued on next page.

¹ SCC-14s may be positioned on two opposite side panels of a tray provided they are printed directly onto the tray via an ink-jet printer. This provision applies only to conveyor lines operating at a speed of 25 cases per minute or higher at the location where the ink-jet printing is performed.

² Optional at supplier's discretion.

CHART 2 (cont'd) – SHIPPING CONTAINER MARKINGS

MARKINGS	LOCATION	MIN HEIGHT	PRINT	OTHER SPECIFICATIONS
Best Before Date	<p>Cartons: On same side panel or same end panel as shipping container code.</p> <p>Trays: Optional ²</p>	1.27 cm (0.5")	Bold	<p>Appropriate wording must clearly indicate that a Best Before date is being used, e.g.,</p> <p style="text-align: center;">BEST BEFORE END OF</p> <p>01 02 03 04 05 06 07 08 09 10 11 12 – 03 07 05</p> <p>"Best Before/Freshness Date" in a Month/Year format, e.g., Jan. 2007</p> <p>"Best Before/Freshness Date" in a numeric or alphanumeric format appearing as dd/mm/yyyy or yyyy/mm/dd, e.g.,</p> <p>Numeric (21-01-2007) Alphanumeric (21-A-2007)</p> <p>Numeric (2007-01-21) Alphanumeric (2007-A-21)</p> <p>Note: The letter <i>I</i> is omitted from the alpha-numeric format. A space, back-slash or hyphen may be used to separate the dd/mm/yyyy or yyyy/mm/dd.</p>
(3) Sales Unit	<p>Cartons: On same end panel as shipping container code.</p> <p>Trays: Optional</p>	1.27 cm (0.5")	Bold	<p>The number of Sales Units per shipping container. Place on the same line immediately preceding the Unit Size, e.g., 12 x 750 mL.</p> <p>For multiple-pack consumer units, indicate the number of sales units per shipping container and the number of units per sales unit, x the net quantity, e.g., 4(6 x 355 mL).</p>
(4) Unit Size	<p>Cartons: On same end panel as shipping container code.</p> <p>Trays: Optional</p>	1.27 cm (0.5")	Bold	<p>The metric net quantity of the Sales Unit expressed in litres (L) or millilitres (mL).</p> <p>Place on same line and immediately following the Sales Unit, e.g., 12 x 750 mL.</p>
(5) Shipping Container Weight	<p>Cartons: On one end panel.</p> <p>Trays: Optional</p>	1.27 cm (0.5")	Bold	<p>The actual weight of a full shipping container expressed in kilograms. A variance of plus or minus (\pm) 0.3 kg from the declared weight is permitted. The maximum case weight allowed is 18.9 kg (actual and declared).</p>
(6) Product Description	<p>Cartons: On same end panel as shipping container code.</p> <p>Trays: Optional</p>	1.06 cm (0.42")	Bold	<p>Description of the product including the brand name. May include vintage or other relative information, e.g., World Vineyards Chenin Blanc 2000 (see Section 4).</p>
(7) Product Type ²	<p>Cartons: On same end panel as shipping container code.</p> <p>Trays: Optional</p>	1.27 cm (0.5")	Bold	<p>Generic description of product type (e.g., red wine, white wine, liqueur, etc.).</p>

² Optional at supplier's discretion

1.4 Description of Product on Shipping Container

- 1.4.1 The intent of this requirement is to allow for easy recognition of the product where scanning is not normally used, e.g., the stock area of retail stores.
- 1.4.2 The human readable description of the retail product must appear on all shipping containers. The brand name must be included if the same product, e.g., White Rum or Chenin Blanc, is offered by multiple suppliers. The vintage year may also be included at the supplier's option.
- 1.4.3 The description may be printed directly onto the shipping container, applied on a label or incorporated into the pre-printed package graphics.

Note: Products packaged in trays are exempt if the contents of the tray can be readily identified without removing it from the tray.

1.5 LCBO Number (formerly CSPC)

- 1.5.1 The Canadian Standard Product Code (CSPC) is now obsolete.
- 1.5.2 The LCBO Number **is not to appear** on shipping containers.
- 1.5.3 The LCBO Number is strictly for internal use only.
- 1.5.4 Corrective action will be required if an incorrect LCBO # appears on shipping containers. Suppliers will be responsible to cover all costs for corrective action taken by the LCBO.
- 1.5.5 The LCBO recognizes the fact that other liquor jurisdictions may continue to require suppliers to print CSPC Numbers on shipping containers, however this practice is **not permitted** in Ontario.

2. SHIPPING CONTAINER CODES (SCC-14)

General Information

Symbol Format

Acceptable Bar Code Formats

Symbol Size, Location and Human Readable Characters

Standards for Scannability

2. SHIPPING CONTAINER CODES (SCC-14)

2.1 General Information

2.1.1 The LCBO requires a Shipping Container Code (SCC-14) on all shipping containers. These codes are required in addition to all other Shipping Container Markings referred to in Section 1.

Note: *Each U.P.C./EAN requires a unique SCC-14. An SCC-14 cannot be assigned to more than one U.P.C./EAN. A U.P.C./EAN cannot be assigned to more than one SKU (LCBO Item Number), except value adds.*

2.1.2 Shipping Container Code information in this document is provided as a guide. Readers are encouraged to consult the Canadian Association of Liquor Jurisdictions (CALJ) *Product Identification Standards for Use in the Distribution of Beverage Alcohol*. The CALJ manual provides detailed information relating to bar code requirements for Consumer Units, Shipping Container Codes and Serial Shipping Container Codes. Copies are available on-line at the LCBO's Trade Resources Online site, <http://www.doingbusinesswithlcbo.com/>.

2.1.3 Global Trade Identification Number (GTIN) is a new term that has been introduced to collectively refer to all U.P.C. and EAN bar codes.

2.1.4 Additional Shipping Container Code information is available from the Electronic Commerce Council of Canada (ECCC), Don Mills Ontario, the Uniform Code Council (UCC), Dayton, Ohio, USA, or a local International Article Numbering Association (EAN) office.

2.2 Symbol Format

2.2.1 Shipping Container Codes are based on a 14-digit number that is usually related to the U.P.C./EAN number assigned to the consumer unit (selling unit).

2.2.2 The symbol is a numeric machine-readable code that identifies the package as a shipping container. The code consists of a single digit packaging indicator number, a two digit number system character (Canadian and U.S. manufacturers are assigned a single digit and are therefore required to use a leading "filler" zero), a 5-digit manufacturer number, a 5-digit item code number and a check digit. All 14 digits must be shown in human readable form.

A Packaging Indicator Number – assigned by the manufacturer to differentiate between different shipping container configurations of the same consumer unit, e.g., 6 units or 12 units per shipping container.

Note: Use 1–8 if the same item number is used for the U.P.C./EAN or "0" (zero) if a different item number is used. Nine (9) is not an acceptable Packaging Indicator Number for shipping containers.

B Number System Character – assigned by the local code council, e.g., Electronic Commerce Council of Canada, Uniform Code Council or International Article Numbering Association.

Note: 1. U.P.C.s use a single digit number system character and therefore require a leading filler "0" (zero).

2. Some EAN codes use a 3 digit number system character. In these shipping containers, the manufacturer number is reduced to 4 digits.

C Manufacturer Number – assigned by the local code council, e.g., Electronic Commerce Council of Canada, Uniform Code Council, or International Article Numbering Association.

D Item Code Number – assigned and controlled by the manufacturer.

E Check Digit – calculated using a specific mathematical formula based on the previous thirteen digits, to ensure accuracy of the encoded information. Refer to the Canadian Association of Liquor Jurisdictions Manual: *Product Identification Standards for Use in the Distribution of Beverage Alcohol* for the formula used to calculate the check digit.

2.2.3 An example of a 14-digit Shipping Container Code format using both the Interleaved 2 of 5 and UCC/EAN 128 symbol is shown below.

	1	00	12345	67890	2	(Interleaved 2 of 5)
*(01)	1	00	12345	67890	2	(UCC/EAN 128)
	↑	↑	↑	↑	↑	
	A	B	C	D	E	

* The human readable Application Identifier (01) is required for all UCC/EAN 128 symbols.

2.3 Acceptable Bar Code Formats

2.3.1 The LCBO will only accept either the Interleaved 2 of 5 or UCC/EAN 128 symbol. UCC/EAN 128 symbols use an application identifier that precedes the 14 digit code and appears in brackets, e.g., (01).

Note: Code 128 is not an accepted bar code symbol.

2.3.2 The Interleaved 2 of 5 symbol is usually better suited for direct printing on shipping containers. The UCC/EAN 128 symbol is smaller but requires a higher printing resolution. The UCC/EAN 128 symbol is the preferred choice when printing on labels.

Interleaved 2 of 5 Symbol



Shipping Container Code – Interleaved 2 of 5 with bearer bar.
Note: magnification not at nominal 100% size.

UCC/EAN 128



Shipping Container Code - UCC/EAN 128 format. Note: not actual size.
The dotted lines indicate the location of the borders of the quiet zones.

2.4 Symbol Size, Location and Human Readable Characters

- 2.4.1 For technical specifications concerning bar code size, location and location of human readable characters, refer to the Canadian Association of Liquor Jurisdictions, *Product Identification Standards for Use in the Distribution of Beverage Alcohol*.

2.5 Standards for Scannability

- 2.5.1 All bar coding symbols on shipping containers must meet the standards for quality established by the Electronic Commerce Council of Canada, the Uniform Code Council Inc. (USA), and the International Article Numbering Association (EAN).
- 2.5.2 In a warehouse or retail environment, a 100% scannability rate must be achieved for all Shipping Container Codes.
- 2.5.3 Symbol quality should be measured with an approved verifier using the test procedures defined by the Electronic Commerce Council of Canada and the Uniform Code Council. The **minimum** acceptable test scores are:

Bar Code	ANSI RATING		Aperture Size
	Numeric	Alpha	
Interleaved 2 of 5	0.5	D	20 mils
UCC/EAN 128	1.5	C	10 mils

* Based on a verifier using light with a wave length of 670 nm ± 10 nm.

- 2.5.4 For more detailed information concerning ANSI, refer to Appendix-A.

3. SHIPPING CONTAINER DESIGN SPECIFICATIONS

General Information

Wooden Cartons

Corrugated Fibreboard Cartons

Die Cut Handles

Corrugated Fibreboard Trays

Shrink Wrap for Corrugated Fibreboard Trays

Cans and PET Shipped in Trays

Glass Bottles Shipped in Trays

Multi-Pack Consumer Units

Facings and Corrugating Mediums

Folds and Joints

Perforations and Zippers

Bottle Partitions & Head Space

3. SHIPPING CONTAINER DESIGN SPECIFICATIONS

Introduction

LCBO Product packaging standards are intended to ensure the safe handling of beverage alcohol products throughout the entire supply chain, from transportation to warehousing to retail. Compliance is mandatory and a condition of doing business with LCBO. Packaging integrity is based on a number of different key elements that when combined create a safe and secure container in which to ship product. These elements include the outer shipping container which forms the basis of the carton, internal bottle partitions, method of sealing the containers and the tightness of the fit of the consumer units packaged inside. When all elements are combined and compliance is achieved, LCBO will be able to ship, warehouse, pick and deliver the consumer units to their intended destination, our retail store shelves.

3.1 General Information

- 3.1.1 Shipping container design specifications apply to the containers in which consumer units are packaged for shipment. This includes both **cartons** and **trays**.
- 3.1.2 All products purchased by the LCBO, including LCBO Category, Vintages Front-Line Release and Vintages Essential products, **must** be packaged in accordance with the requirements set out in this document. Non-compliance may result in rejection of shipments, levying of a non-compliance penalty to recover additional operating expenses or corrective rework to bring packaging into compliance. All non-compliance penalties and rework charges are debited against the supplier's corporate account and deducted from payment.
- 3.1.3 Refer to Appendix B for additional **Terms and Definitions** used throughout this Section.
- 3.1.4 Shipping Container materials must be recyclable. The use of non-essential, extraneous materials for aesthetic or other non-functional purposes that do not affect the structural design of the shipping container, are **not** permitted.
- 3.1.5 There are two types of shipping containers; **cartons** and **trays**. Individual glass bottles, P.E.T., Tetra Pak packaging, Bag-in-Box packages or alternative packaging such as Flexipacks must be shipped in cartons. Cans or glass bottles packaged in multi-pack consumer units may be shipped in cartons or trays.
- 3.1.6 Shipping container dimensions shall not be less than:
 - H – Height** 11.5 cm (4.5 in.)
 - L – Length** 20.0 cm (7.9 in.)
 - W – Width** 16.0 cm (6.3 in.)
- 3.1.7 Shipping container dimensions shall not be larger than:
 - H – Height** 51.0 cm (20.1 in.)
 - L – Length** 54.0 cm (21.3 in.)
 - W – Width** 40.6 cm (16.0 in.)
- 3.1.8 The maximum case weight for shipping containers is **18.9 kg** or **41.6 lbs**. Shipping containers found to be in excess of this weight will be assessed a non-compliance penalty and/or may be dismantled and re-packed to be brought into compliance. Non-compliance penalties and rework charges are debited against the supplier's corporate account and deducted from payment.

3.2 Wooden Cartons (Vintages Products Only)

- 3.2.1 Shall be constructed entirely from wood materials meeting the phytosanitary requirements set out in Section 4.4.
- 3.2.2 The minimum thickness of all solid wood materials is 8.0 mm (5/16 inches)
- 3.2.3 Cartons must be securely sealed (wood staples, nails, screws, glued) in such a manner that cartons remain properly assembled and closed during filling, transportation, storage and distribution through warehouse facilities.
- 3.2.4 Cartons must have separators (partitions) that prevent displacement of selling units and bottle to bottle contact.

3.3 Corrugated Fibreboard Cartons

3.3.1 Cartons shall be constructed from:

- A, B, or C flute single-wall corrugated fibreboard; or
- B and C or C and B flute double-wall corrugated fibreboard

3.3.2 All facings and corrugating mediums of cartons shall be constructed from either Kraft paper or recycled paperboard weighing not less than 26 pounds per 1,000 square feet (0.13 kg/m²).

3.3.3 **Vintages** products may be packaged in wooden cases (refer to Section 3.2).

3.3.4 **Continental North American LCBO and Vintages Essential** products shall be packaged in cartons that meet the applicable technical specifications listed in Chart 3 for the consumer unit package material type.

3.3.5 **Non-Continental North American LCBO and Vintages Essential** products shall be packaged in cartons that meet the applicable technical specifications listed in Chart 4 for the consumer unit package material type and consumer unit capacity (container size).

3.3.6 **Vintages Front-Line Release** products shall be packaged in cartons that meet the applicable technical specifications listed in Chart 5 for the consumer unit package material type.

3.3.7 Cartons **must** be of a single case design. Split cartons or two cartons bound together are **unacceptable**. Refer to Figures 1, 2, 3, 4 & 5 for examples of acceptable box styles.

3.3.8 Cartons **must** be securely sealed by a method of adequate strength and quality, so that they remain properly assembled and closed during filling, transportation, storage and distribution through automated warehouse facilities. Staples are not permitted.

Note: Firm gluing is evident when mutilation of the surface fibre accompanies separation of joined areas.

3.3.9 A gap of up to 0.25" (0.64 cm) will be permitted between the outer top flaps to allow for automatic machine sealers.

3.3.10 Consumer units **must** be packaged inside the shipping container in such a manner as to completely fill the container, and must be securely packaged within the container to prevent displacement. Headspace **is not** allowed between the top of the consumer units and the inner flaps of the shipping container.

CORRUGATED FIBREBOARD CARTONS – ACCEPTABLE BOX STYLES

Conventional Slotted Shipping Containers

Figure 1: Regular Slotted Shipping Container

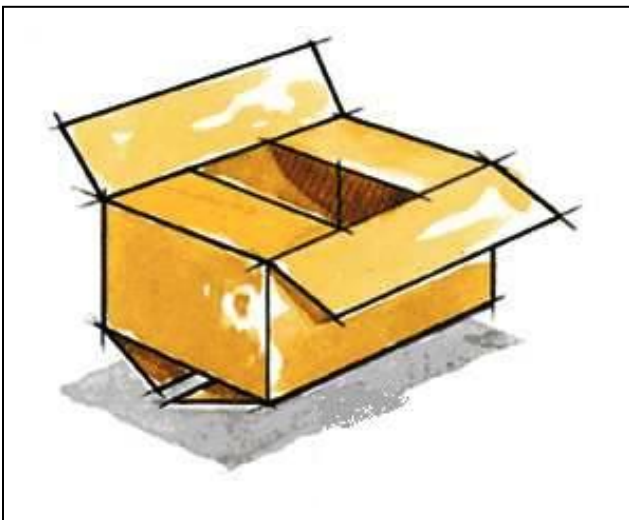
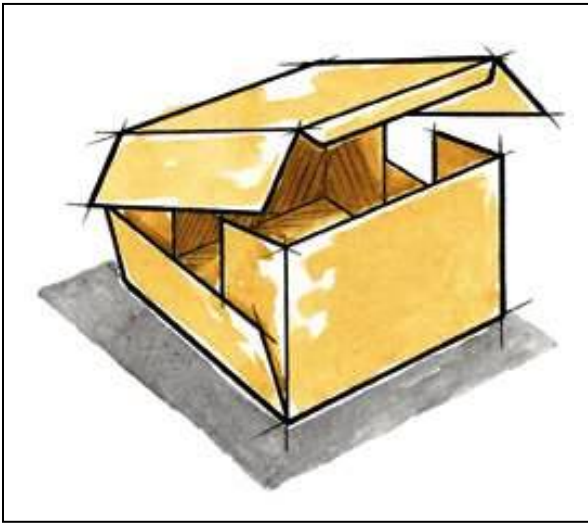

Figure 2: Regular Slotted Overlap Shipping Container



Five Panel Folder Shipping Containers

Figure 3: Five Panel Folder



Bottom Tuck Flap Shipping Containers

Figure 4: Regular Slotted with Bottom Tuck Flap

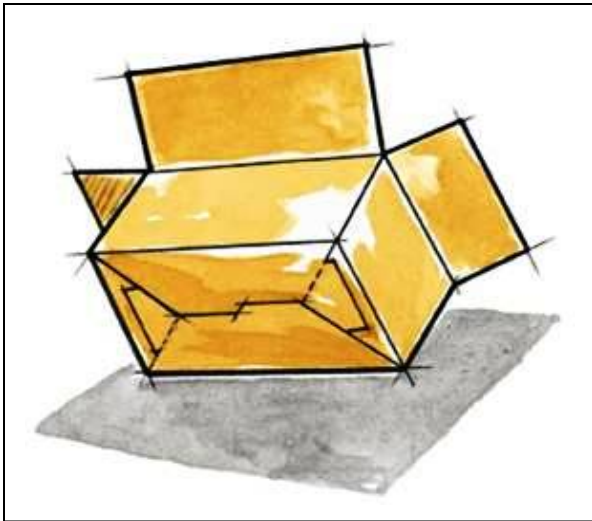
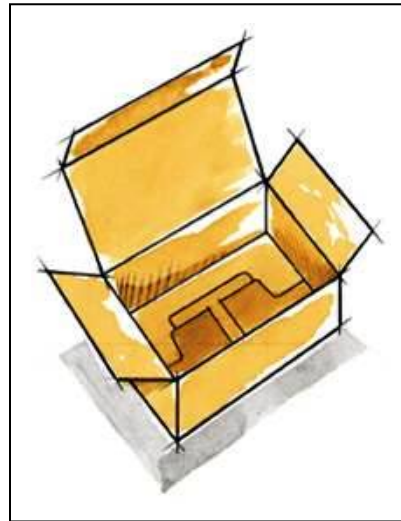

Figure 5: Overlap with Bottom Tuck Flap



3.4 Die Cut Handles (see photo on right)

- 3.4.1. Suppliers, at their discretion, are permitted to incorporate die cut handles into the end panels of corrugated fibreboard cartons.
- 3.4.2. Die cut handles must be positioned on the end panels so that the total weight of carton is balanced when completely filled with consumers selling units.

Die Cut Handle

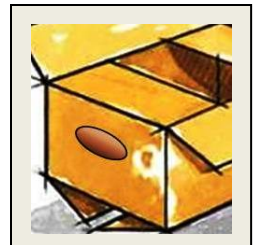

3.4.3 The perimeter of the interior liner board around the die cut must be reinforced in such a manner as to prevent tearing of the corrugated fiberboard when the cartons are handled under normal conditions.

CHART 3 – Continental North American Products (LCBO & Vintages Essentials)					
Consumer Unit Packaging Materials	Consumer Unit Net Quantity	Shipping Container Box Rating (Select Option 1, 2 or 3)			Bottle Partitions Required
		Option 1 <i>(Minimum Burst Strength Required)</i>	Option 2 <i>(No Minimum Burst Strength)</i>	Option 3 <i>(No Minimum Burst Strength)</i>	
		Single-Wall Corrugate	Double-Wall Corrugate	Edge Crush Test Rating ¹	
Glass Bottles	1.0 L or smaller	A, B, or C Flute 175 p.s.i. (1207 kPa)	Any combination of C and B or any combination of C or B with A or E or F	32 ECT	Yes See Chart 8
	Larger than 1.0 L	A or C Flute 200 p.s.i. (1379 kPa)			
P.E.T. or Aluminum and Steel Cans	1.0 L size or smaller	A, B, or C Flute 175 p.s.i. (1207 kPa)	Any combination of C or B with A or E or F	40 ECT	Optional
	Greater than 1.0 L up to 2.0 L	A or C Flute 200 p.s.i. (1379 kPa)			
Tetra Pak /Flexipack (Cheer Pack®)	All container sizes	A or C Flute 275 p.s.i. (1896 kPa)	Any combination of C and B or any combination of C or B with A or E or F	44 ECT	Optional
Bag-in-Box	Not exceeding 4.0 L in capacity	A or C Flute 275 p.s.i. (1896 kPa)			
Multi-Pack Selling Units: Glass Bottles or Aluminum Cans or P.E.T.	All container sizes	A or C Flute 175 p.s.i. (1207kPa)	Any combination of C or B with A or E or F	32 ECT	Optional

¹ The corrugated box manufactures ECT rating stamp is required to appear on the bottom of the carton. If the stamp is not present the carton will be required to meet the applicable bursting strength.

CHART 4 – Non-Continental North American Products (LCBO & Vintages Essentials)

Consumer Unit Packaging Materials	Consumer Unit Net Quantity	Shipping Container Box Rating (Select Option 1, 2 or 3)			Bottle Partitions Required
		Option 1 <i>(Minimum Burst Strength Required)</i>	Option 2 <i>(No Minimum Burst Strength)</i>	Option 3 <i>(No Minimum Burst Strength)</i>	
		Single-Wall Corrugate	Double-Wall Corrugate	Edge Crush Test Rating ¹	
Glass Bottles	1.0 L or smaller	A, B, or C Flute 200 p.s.i. (1379 kPa)	Any combination of C and B or any combination of C or B with A or E or F	32 ECT	Yes See Chart 8
	Larger than 1.0 L	A or C Flute 200 p.s.i. (1379 kPa)			
P.E.T. (Polyethylene Terephthalate) or Aluminum and Steel Cans	All container sizes	A or C Flute 200 p.s.i. (1379 kPa)		40 ECT	Optional
Tetra Pak /Flexipack (Cheer Pack®)	All container sizes	A or C Flute 275 p.s.i. (1896 kPa)		44 ECT	Optional
Multi-Pack Selling Units: Glass Bottles or Aluminum Cans or P.E.T.	All container sizes	A or C Flute 175 p.s.i. (1207kPa)		32 ECT	Optional

¹ The corrugated box manufactures ECT rating stamp is required to appear on the bottom of the carton. If the stamp is not present the carton will be required to meet the applicable bursting strength.

CHART 5 – Front-Line Vintages Release Products

Consumer Unit Packaging Materials	Consumer Unit Net Quantity	Shipping Container Box Rating (Select Option 1, 2 or 3)			Bottle Partitions Required
		Option 1 <i>(Minimum Burst Strength Required)</i>	Option 2 <i>(No Minimum Burst Strength)</i>	Option 3 <i>(No Minimum Burst Strength)</i>	
		Single-Wall Corrugate	Double-Wall Corrugate	Edge Crush Test Rating ¹	
Glass Bottles	All container sizes	A or C Flute 175 p.s.i. (1207kPa)	Any combination of C and B or any combination of C or B with A or E or F	32 ECT	Yes See Chart 8
Aluminum and Steel Cans	All container sizes	A or C Flute 175 p.s.i. (1207kPa)			Optional
Multi-Pack Selling Units: Glass Bottles or Aluminum Cans	All container sizes	A or C Flute 175 p.s.i. (1207kPa)			

¹ The corrugated box manufactures ECT rating stamp is required to appear on the bottom of the carton. If the stamp is not present the carton will be required to meet the applicable bursting strength.

3.5 Corrugated Fibreboard Trays

- 3.5.1 Individual glass bottles and Tetra Pak, Flexipack or Bag-In-A-Box packages **may not** be shipped in trays.
- 3.5.2 Trays shall be constructed from:
 - A, B, or C flute single-wall corrugated fibreboard; or
 - B and C or C and B flute double-wall corrugated fibreboard
- 3.5.3 All facings and corrugating mediums of trays shall be constructed from either Kraft paper or recycled paperboard weighing not less than 26 pounds per 1,000 square feet (0.13 kg/m²).
- 3.5.4 Trays shall meet the applicable technical specifications listed in Chart 6 for the type of consumer unit packaging materials used.
- 3.5.5 The height of the tray walls shall be at least one-third (1/3) the height of the consumer units package inside, but not less than 2.5" (6.4 cm).
- 3.5.6 Packaging stability shall be maintained through application of an adequate, recyclable, shrink wrap material (refer to see Section 3.6).
- 3.5.7 LCBO Shipping Container Markings shall apply to all trays; refer to Chart 2.

CHART 6 – Standards For Corrugated Fibreboard Trays

Consumer Unit Packaging Materials	Consumer Unit Net Quantity	Shipping Container Box Rating (Select Option 1, 2 or 3)			Bottle Partitions Required
		Option 1 <i>(Minimum Burst Strength Required)</i>	Option 2 <i>(No Minimum Burst Strength)</i>	Option 3 <i>(No Minimum Burst Strength)</i>	
		Single-Wall Corrugate	Double-Wall Corrugate	Edge Crush Test Rating ¹	
Multi-Pack Selling Units: Glass Bottles ² or Aluminum Cans or P.E.T. (Polyethylene Terephthalate)	All sizes	A , B or C Flute 175 p.s.i. (1207kPa)	Any combination of C and B or any combination of C or B with A or E or F	32 ECT	No
Single Selling Units: Aluminum Cans or P.E.T. (Polyethylene Terephthalate)	All sizes	A or C Flute 175 p.s.i. (1207kPa)			
¹ The corrugated box manufactures ECT rating stamp is required to appear on the bottom of the tray. If the stamp is not present the tray will be required to meet the applicable bursting strength.					
² Glass must be packaged in fully enclosed Multi-pack consumer units					

3.6 Shrink-Wrap for Corrugated Fibreboard Trays

- 3.6.1 Care must be taken to ensure that the side and end panels of the shipping containers remain flat, smooth and free of any physical irregularities between the bottom of the container and a height of 3.5" (8.9 cm).
- 3.6.2 The minimum thickness of the shrink-wrap for the corrugated fibreboard trays is 2.5 mils (0.0025" or 0.0635 mm).
- 3.6.3 When visually inspecting the fibreboard trays the tension of the shrink-wrap must be tight.
- 3.6.4 Seams or other imperfections must not interfere with the application of labels onto the side or end panels of the trays. They must run the length of the tray over the top, bottom and end panels. Seams are not permitted to run along the length of the side panels.
- 3.6.5 Shrink wrap shall be applied in such a manner as to ensure the shrink wrap material completely envelops the entire tray and the contents of the tray. Openings in the end panels, e.g., "donut holes" are permitted provided the shrink-wrap material overlaps each vertical or horizontal edge by at least 6.35 cm (2.5 inches).

3.7 Cans and P.E.T. (Polyethylene Terephthalate) Shipped in Trays

- 3.7.1 Products packaged in cans or P.E.T., not exceeding 5 litres in capacity, may be shipped in single-wall corrugated fibreboard trays.
- 3.7.2 The total combined capacity of the individual units per tray shall not exceed 12 litres.
- 3.7.3 The configuration of the units packaged within the tray shall not exceed:
 - more than two (2) units for container sizes greater than 4L and up to and including 5L
 - more than four (4) units for container sizes greater than 2L and up to and including 4L
 - more than six (6) units for container sizes greater than 1L and up to and including 2L
 - more than twelve (12) units for container sizes greater than 500 mL and up to and including 1L
 - more than twenty-four (24) units for container sizes up to and including 500 mL

3.8 Glass Bottles Shipped in Trays

- 3.8.1 Glass bottles **may not** be shipped in trays unless the individual bottles are packaged in multi-pack consumer units - see requirements for multi-pack consumer units set out in Section 3.9.
- 3.8.2 Multi-pack consumer units must meet the minimum packaging requirements set out in Section 3.9 and conform to the following conditions:
 - The bottle size shall not exceed 500 mL in capacity; and
 - The total number of bottles per multi-pack consumer unit shall not exceed 15; and
 - The total number of bottles per tray shall not exceed 30.

3.9 Multi-Pack Consumer Units

Multi pack consumer units that are not shipping containers, e.g. 4, 6, 12 and 15 packs, and must be packaged and shipped in a shipping container, either a carton (reference Section 3.3) or tray (reference Section 3.5), and conform with the minimum requirements as outlined below.

- 3.9.1 Multi-pack consumer units shall be made from:
 - E or F flute corrugated fibreboard having a bursting strength of not less than 125 pounds per square inch (1207 kPa), or
 - Solid fibreboard callipering not less than 0.060 cm (0.024"), having a bursting strength of not less than 125 pounds per square inch (1207 kPa).
- 3.9.2 The units shall be designed in a manner that provides adequate protection against breakage and damage during handling.
- 3.9.3 Multi-pack consumer units must be securely assembled by a method of adequate strength and quality, so that units remain properly assembled during normal transportation and handling.

- 3.9.4 Manufacturer's joints shall be secured using a water resistant adhesive.
- 3.9.5 Open ended carriers are not permitted.
- 3.9.6 The number of units per consumer unit shall not exceed 15 and the capacity per unit shall not exceed 500 mL.
- 3.9.7 The total number of individual consumption units per tray shall not exceed 30.
- 3.9.8 LCBO Consumer Unit Labelling Requirements shall apply to all multi-pack consumer units.

3.10 Facings and Corrugated Mediums

- 3.10.1 All facings and corrugating mediums of cartons, trays, liners, pads and partitions shall be constructed from either Kraft paper or recycled paperboard weighing not less than 26 pounds per 1,000 square feet (0.13 kg/m²).
- 3.10.2 Facings shall be firmly glued to the corrugating mediums at all points of contact using a wet strength adhesive.
- 3.10.3 Corrugating flutes shall meet the technical specifications listed in Chart 7 for the applicable flute rating.

Figure 6: Types of Corrugated Paperboard

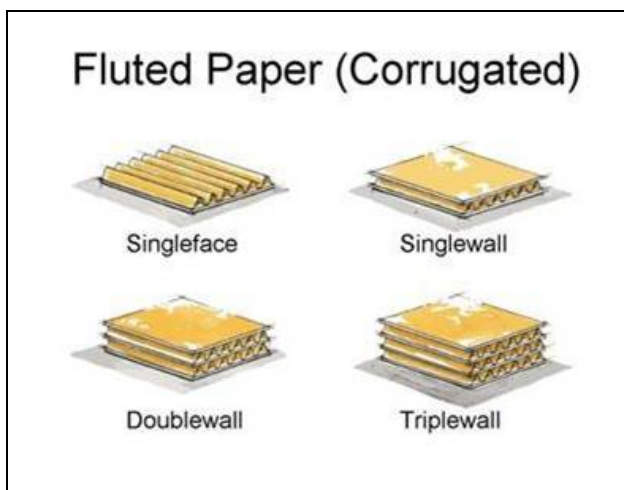

Figure 7: Examples of Corrugated Flutes

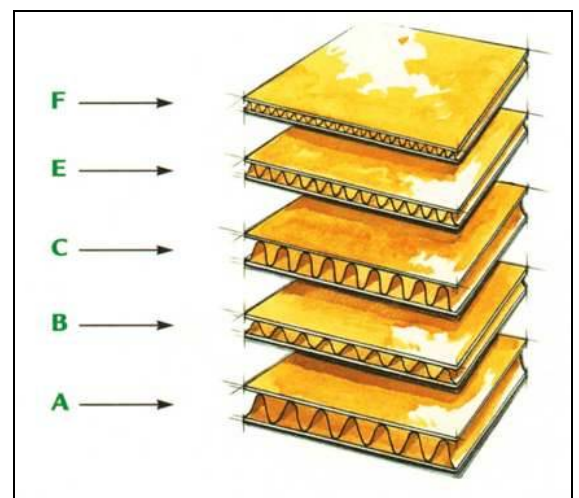

Chart 7 - Specifications For Corrugated Flutes				
Flute Designation	Flutes per linear foot	Flute thickness (in)	Flutes per linear meter	Flute thickness (mm)
A flute	33 +/- 3	3/16	108 +/- 10	4.8
B flute	47 +/- 3	1/8	154 +/- 10	3.2
C flute	39 +/- 3	5/32	128 +/- 10	4.0
E flute	90 +/- 4	1/16	295 +/- 13	1.6
F flute	128 +/- 4	1/32	420 +/- 13	0.8

3.11 Folds and Joints

- 3.11.1 Folds should be achieved by scoring the corrugated fibreboard.
- 3.11.2 Perforations for the purpose of creating folds are permitted provided the perforations do not reduce the structural integrity of shipping containers or cause an increase in damage that may occur during normal handling. A non-compliance penalty may be assessed if damage results in packaging failure or breakage.
- 3.11.3 Manufacturer's joints shall be secured by lapping the sides of the carton or tray forming the joint not less than 1.25" (3.18 cm) and fastening the joint by firmly gluing the joint with a water resistant adhesive.
- 3.11.4 Firmly glued shall mean by a method of adequate strength and quality so that they remain properly assembled during filling, transportation and storage.

Note: Firm gluing is evident when mutilation of the surface fibre accompanies separation of joined areas.

3.12 Perforations and Zippers

- 3.12.1 Perforations intended to create openings within a shipping container to display or remove product are prohibited.
- 3.12.2 Perforations for the purpose of creating folds (see 3.11) are permitted provided the perforations do not reduce the structural integrity of shipping containers or cause an increase in damage that may occur during normal handling. A non-compliance penalty may be assessed if damage results in packaging failure or breakage
- 3.12.3 Zippers are permitted, provided the strength and integrity of the corrugated board is not compromised, e.g., perforations are not permitted.

3.13 Bottle Partitions & Head Space

- 3.13.1 **Definition:** A set of corrugated or solid fibreboard pieces slotted so that they interlock when assembled to form a number of cells into which articles may be placed for shipment (reference Figure 8).
- 3.13.2 When required (reference Charts 3, 4 and 5), partitions must provide adequate protection against damage or breakage and prevent direct bottle to bottle contact.
- 3.13.3 Partitions provide vertical stability during transportation and storage.
- 3.13.4 Partitions must not be less than full shoulder height of the consumer selling unit (reference Figure 9).
- 3.13.5 Partitions must be assembled so they remain interlocked.
- 3.13.6 When inserted into shipping containers, partitions must be secured in a manner that will prevent them from becoming displaced. Displacement may occur during normal handling caused by shaking, vibrations occurring during transit or caused by automated conveyers or palletizing equipment or when the shipping containers are inverted.

The following are examples of how partitions can be secured within shipping containers:

- i) at least 1 piece of corrugated or solid fibreboard extends the full height of the shipping container (reference Figure 9); or
 - ii) an adhesive compound applied to 1 surface of the partition in such a way as to bond it to 1 of the inner surfaces of the shipping container; or
 - iii) designed in such a manner that the consumer selling unit holds the partition in place, e.g., a flap that forms a 'U' shape across the bottom of a cell that is held in place by the base of the consumer selling unit.
- 3.13.7 The technical specifications of the partitions vary depending on the capacity of the individual consumer unit and the type of fibreboard used. Refer to Chart 8 for detailed technical specification.
 - 3.13.8 Consumer selling units must be packaged inside the shipping container in such a manner as to completely fill the container, and must be securely packaged within the container to prevent displacement. Head space is not allowed between the top of the consumer unit and the inner flaps of the shipping containers..

Figure 8



Figure 9

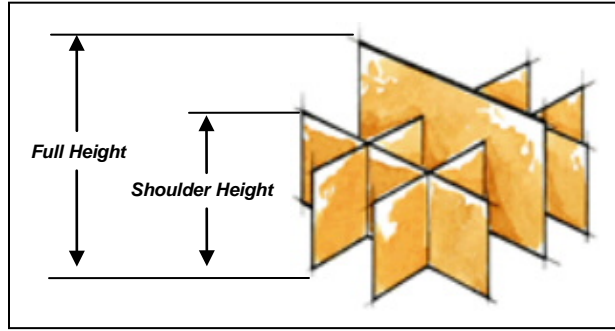

Note: It is important to recognize that corrugated containers expand and contract based on the environment they are exposed to. A container exposed to high humidity or moisture levels (like those experienced in ocean travel) may become less rigid prior to arriving at the LCBO. This results in increased bottle-to-bottle contact in shipping cartons missing or with inadequate partitions, as well as increased breakage when compared to shipping containers with adequate partitions.

CHART 8 – BOTTLE PARTITIONS		
CAPACITY OF INDIVIDUAL CONTAINERS (Millilitres & Ounces)		BOTTLE PARTITIONS (Reference Charts 3, 4 & 5)
FROM	TO	
more than 187 mL more than 7 oz	710 mL 25 oz	1 or 2 or 3
more than 710 mL more than 25 oz	994 mL 35 oz	1 or 2 or 4 or 5
more than 994 mL more than 35 oz	1278 mL 45 oz	1 or 5 or 6 or 7
more than 1278 mL more than 45 oz	2556 mL 90 oz	2 or 6 or 7
more than 2556 mL more than 90 oz	4000 mL 140 oz	7
PARTITIONS REQUIREMENTS		
<ol style="list-style-type: none"> 1. Partitions A, B, or C flute single-wall corrugated fibreboard, minimum bursting strength of 125 pounds per square inch (862 kPa). 2. Partitions A or C flute single-wall corrugated fibreboard, minimum bursting strength of 125 pounds per square inch (862 kPa). 3. Partitions, solid paperboard 0.016" (0.41 mm) thick. 4. Partitions, solid paperboard 0.040" (1.02 mm) thick, 130 lbs. per 1,000 square feet (0.63 kg/m²). 5. Partitions, solid paperboard, 2 thicknesses, each 0.024" (0.61 mm) thick, 65 lbs. per 1,000 square feet (0.32 kg/m²). 6. Partitions, solid paperboard 0.047" (1.19 mm) thick, 142 lbs. per 1,000 square feet (0.69 kg/m²). 7. Partitions, A, B, or C flute double-wall corrugated fibreboard, minimum bursting strength 125 pounds per square inch (862 kPa). 		

4. TRAILERS AND INTER-MODAL CONTAINERS

Trailers and Inter-Modal Containers

Loads Shipped In Trailers

Loads Shipped in Inter-Modal Containers

Phytosanitary Requirements

Protective Service (TCC's)

Pull Force Test Method for Measurement of CoF

4. TRAILERS AND INTER-MODAL CONTAINERS

4.1 Trailers and Inter-Modal Containers

- 4.1.1 **Trailers** are un-powered vehicles with chassis and axle assemblies that are pulled by powered vehicles travelling by roadway.
- 4.1.2 **Inter-Modal Containers** are containers without a chassis that can be loaded and sealed in tact and shipped using multiple modes of transportation – e.g. rail, ocean vessel, and truck.
- 4.1.3 Finished pre-package products originating from countries **within** Continental North America must be shipped on CPC or equivalent hardwood pallets in accordance with all requirements detailed in Section 4.2.
- 4.1.4 Finished pre-package products originating from countries **outside** Continental North America shall be shipped in inter-modal containers in accordance with all requirements detailed in Section 4.3

4.2 Loads Shipped In Trailers (Highway Loads)

- 4.2.1 Mandatory for all Continental North American products.
- 4.2.2 **Must** be shipped on Canadian Pallet Council (CPC) or equivalent **hardwood** pallets e.g. CHEP, TBS, EURO, 48" x 40". Both stringer and bloc style pallets are acceptable.
- Note: All products manufactured or packaged and delivered within Continental North America must be delivered on CPC or equivalent pallets, conforming to all the requirements outlined in this Section.*
- 4.2.3 Pallets must be free of quality defects and meet Phytosanitary Requirements outlined in Section 4.4 and meet the following additional criteria:
- Have a minimum safe maximum load rating of 2,800 lbs.
 - Have a minimum Lateral Collapse Resistance Rating of Excellent.
 - Deck boards must have a minimum 80% deck coverage.
 - Deck board gaps cannot exceed 2 inches.
 - Stringers must be a minimum of 2 and ¾ inches thick.
- 4.2.4 CPC or equivalent pallet base dimensions and maximum weight:

Pallet Base Style: 121.92 cm x 101.6 cm (48" x 40"), Height = 14.3 cm (5.625")

Maximum Overhang* – Length: 1.27 cm (0.5") on each end

Maximum Overhang* – Width: 1.27 cm (0.5") on each side

Maximum Pallet Height (including pallet): 154.3 cm (60.75")

Maximum Pallet Weight (including pallet): 1329 Kg (2,930.4 lbs)

** No Overhang permitted for non-weight bearing selling unit SKU's, e.g. Tetra Pak/flexi pack or Bag-in-a-box*

- 4.2.5 Pallets shall contain no more than one Stock Keeping Unit (SKU). Partial pallets may be stacked provided each pallet contains no more than one SKU and the tiers are in even increments, e.g., each tier contains an equal number of shipping containers.
- 4.2.6 Each SKU shall be palletized according to its assigned TI HI (Tiers, referring to the number of cases per tier and Heights, referring to the number of tiers per pallet) using an interlocking piling pattern where available. As part of the listing procedure, suppliers will be provided with a SKU specific TI HI based on the shipping container dimensions and weight for each SKU granted a listing. Once approved, TI HI's cannot be changed without authorization.
- 4.2.7 Shipping Containers must be palletized so that the consumer units packaged inside are orientated in an optimum position to ensure stability. For example, shipping containers with selling units packaged in a vertical position must be palletized so that the selling units are orientated in an upright position and shipping containers with selling units packaged in a horizontal position must be palletized so the selling units remain lying on their sides.

- 4.2.8 Load stability shall be maintained through adequate shipping container to shipping container friction or by the application of a suitable anti-skid coating or cohesive applied between each tier. Use of 'non-slip' tier sheets or similar devices/materials inserted between tiers or between the pallet and the first tier is prohibited.
- 4.2.8.1 For the purpose of 4.2.8, "*adequate shipping container to shipping container friction*" shall mean a Coefficient of Friction (CoF) value of between **0.80** and **0.92**, as determined using the *Pull Force* test method set out in Section 4.6.
- 4.2.9 At a minimum, the top tier must be tied or poly-strapped. Non- weight bearing selling units, e.g., Bag-in-a-box products, require at a minimum the top two tiers to be tied or poly-strapped. Tie ropes or poly-straps must be applied before pallets are stretch or shrink wrapped.
- 4.2.10 Individual pallets may be stretch or shrink wrapped to stabilize pallets during transit provided articles 4.2.5 through 4.2.9 are achieved. Stretch or shrink wrap materials must be recyclable. Corner boards or other similar mechanical devices are prohibited.
- 4.2.11 Pallets shall be loaded into trailers in a manner that balances the load weight across the length and width of the trailer, e.g., staggered.
- 4.2.12 Pallets shall be loaded into trailers in a manner that will prevent load shifting during transit. If required, air bags, restraining bars or other mechanical means may be used to stabilize the pallets.

Note: Suppliers loading trailers or under contract with a third party to load trailers on their behalf, are solely responsible for ensuring adequate measures are taken to stabilize loads for transit. Suppliers will be held liable for any damage that occurs during transit, including breakage and additional handling costs incurred to divert trailers to a third party logistics facility for off-loading.

4.3 Loads Shipped in Inter- Modal Containers

Special Notice: Effective July 3, 2012, all supplier loaded containers of Non-Continental North American product arriving at an LCBO Retail Service Centre are required to be bulk loaded directly onto the container floor without the use of pallets, slip-sheets or other devices..

- 4.3.1 Finished pre-package products originating from countries **outside** Continental North America shall be shipped in 'bulk' loaded inter-modal containers, in accordance with all requirements detailed in this section.
- 4.3.2 Bulk loaded containers are containers with product loaded directly on the container floor, either by hand or by mechanical means.
- 4.3.3 Individual Stock Keeping Units (SKU's) must be loaded in a contiguous manner when multiple SKU's are loaded within the same container. SKU's must be separated from one another across the width of the container. It is permissible to load multiple SKU's in a contiguous manner (see diagram #1 and #2), however, placing the same SKU in different locations throughout the container or intermixing different SKU's is not permitted.
- 4.3.4 Load stability must be maintained using interlocking piling patterns or mechanical devices including; air bags, or restraining bars.
- 4.3.5 Containers must be loaded up to the face of the container doors. If order quantities do not permit this, the load must be adequately secured to prevent shifting (see 4.3.1.4).
- 4.3.6 Shipping containers (cases) shall be loaded into inter-modal containers in a manner that balances the load weight across the length and width of the inter-modal container, e.g., staggered.
- 4.3.7 Shipping Containers must be loaded so that the consumer units packaged inside are orientated in an optimum position to ensure stability. For example, shipping containers with selling units packaged in a vertical position must be loaded so that the selling units are orientated in an upright position and shipping containers with selling units packaged in a horizontal position must be loaded so the selling units remain lying on their sides.
- 4.3.8 All loads must have a minimum 12" (30.48 cm) clear of the top of the container.
- 4.3.9 Individual palletized cubes loaded directly onto the floor of the container, with slip sheets or pallets removed, may be stretch or shrink wrapped to help stabilize the load during transit. Stretch or shrink wrap materials must be recyclable. Corner boards or other similar mechanical devices are prohibited.

- 4.3.10 Palletized cubes shall contain no more than one Stock Keeping Unit (SKU). Partial cubes may be stacked provided each cube contains no more than one SKU and the tiers are in even increments, e.g., each tier contains an equal number of shipping containers.
- 4.3.11 Whenever possible, interlocking piling pattern should be used to construct the cube.
- 4.3.12 Palletized cubes shall be loaded into containers in a manner that balances the load weight across the length and width of the container, e.g., staggered.
- 4.3.13 Palletized cubes shall be loaded into containers in a manner that will prevent load shifting during transit. If required, air bags, restraining bars or other mechanical means may be used to stabilize the pallets.

Note: Suppliers loading inter-modal containers or under contract with a third party to load inter-modal containers on their behalf, are solely responsible for ensuring containers are floor loaded and that adequate measures are taken to stabilize loads for transit. Suppliers will be held liable for any damage that occurs during transit, including breakage and additional handling costs incurred to divert container to a third party logistics facility for off-loading.

Diagram #1 - Bulk Loaded Containers
First Layer

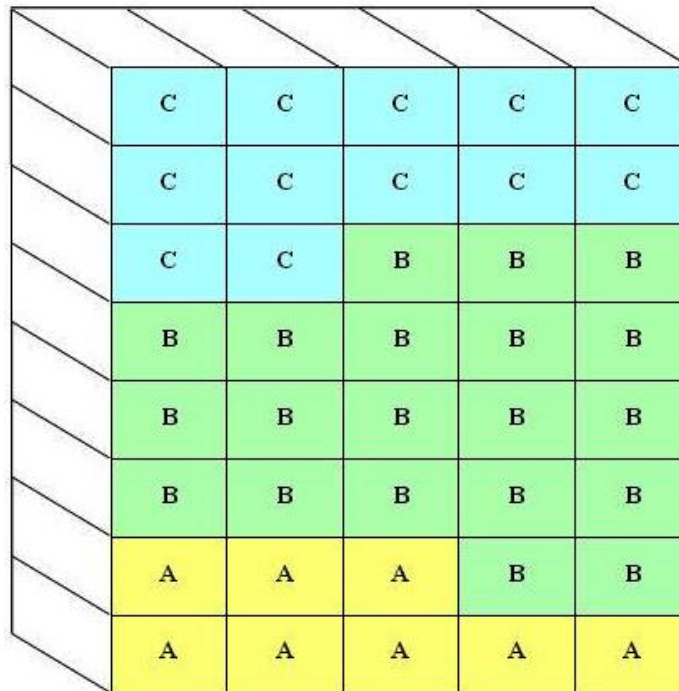
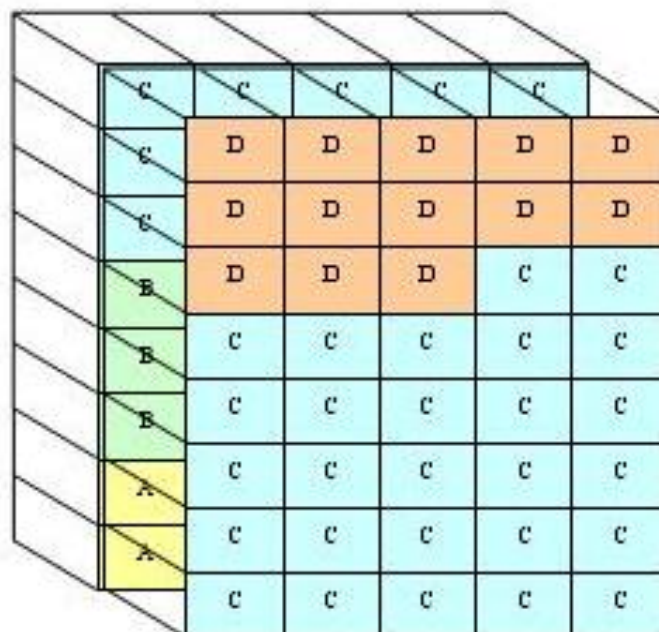
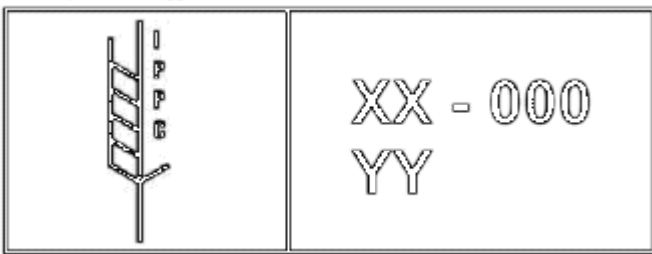

Diagram #2 - Bulk Loaded Containers
First & Second Layers



4.4 Phytosanitary Requirements

- 4.4.1 Canada has adopted www.inspection.gc.ca/english/plaveg/protect/dir/d-98-08e.shtml (ISPM No.15 see 4.4), Guidelines for Regulating Wood Packaging Material (WPM) in International Trade, under Canadian Food Inspection Agency (CFIA) policy directive D-98-08.
- 4.4.2 Any regulated wood packaging material found not to be in compliance with the import requirements specified above may be ordered removed from Canada by CFIA. Additional enforcement measures may also be applied to importers or those persons or entities in care and control of non-compliant wood packaging.
- 4.4.3 All costs associated with the inspection or safe disposal of non-compliant material is the responsibility of the person or entity in care and control of the non-compliant wood packaging materials at the time of entry to Canada. Any costs incurred by the LCBO for non-compliance will be charged back to the vendor.
- 4.4.4 **ISPM No. 15 Standards:**
- (i) Require all wood packaging material (including pallets, dunnage, packing blocks, drums, spools, skids, crating, cases and gift boxes,) to be either heat treated or fumigated with methyl bromide in accordance with the guidelines and marked with an approved international mark certifying treatment¹.
 - (ii) CFIA may approve other treatment measures, if it can be proven that such measures are effective in minimizing the risk of quarantine pests associated with untreated wood packaging materials.
 - (iii) Importers should contact [a local office of the](#) CFIA to enquire about the use of other treatments.
- 4.4.5 Phytosanitary markings must be as indicated below:



- ¹ **XX:** represents the International Standards Organization two letter country code for the country in which the wood packaging is produced
- 000:** represents the official certification number issued to the facility producing the compliant wood packaging by the NPPO
- YY:** represents the treatment carried out, e.g., HT for heat treated wood or MB for methyl bromide treated wood.

- 4.4.6 Exemptions:
- (i) wood packaging materials originating in the continental United States are currently exempt but this exemption will be removed by CFIA at a date still to be determined; and
 - (ii) wood packaging materials made from manufactured wood, such as plywood, oriented strand board, fibre-board, etc., from paper or cardboard products or those made from non-wood articles; and
 - (iii) wood packaging items made from wood less than 6 mm in thickness or from veneer peeler cores. Veneer peeler cores are a by-product of veneer production involving high temperatures and comprising the centre of a log remaining after the peeling process.

4.5 Protective Service (Temperature Controlled Containers)

- 4.5.1 Protective Service means protection provided by way of a mechanical or electrical device in a trailer to protect the beverage alcohol shipment being transported by the carrier from extreme cold or hot temperatures.
- 4.5.2. The LCBO, under contract with its carriers and freight forwarders, shall determine, at its' sole discretion, when and under what conditions TCC's shall be used.

- 4.5.3 “Protective Service” may not be provided by means of an insulated or thermal blanket or similar non-mechanical or electrical devices.
- 4.5.4 Suppliers may not install or place temperature monitoring devices in trailers or inter-modal containers without the express written permission from the LCBO’s Logistic/QA division.

4.6 Pull Force Test Method for Measurement of Static Coefficient of Friction

4.6.1 Scope

- 4.6.1.1 This method may be used to determine the CoF of shipping containers (corrugated cartons or shrink wrapped trays) with or without the application of an anti-skid coating or cohesive.
- 4.6.1.2 This test method determines the ratio of the frictional force resisting movement on the surface being tested to the force applied normal to that surface; known as the coefficient of friction (CoF).
- 4.6.1.3 Weight or pull force is recorded in force units of measurement, e.g., Newton’s, kilopascals (kPa) or pounds per square inch (p.s.i.). Mass is measured in kg or lbs, or equivalent units of measure. The same units must be used for all measurements of force when calculating the CoF so the resulting value is unitless.
- 4.6.1.4 The CoF depends on materials used and range from near zero (0) to greater than one (1).
- 4.6.1.5 *This test method may involve operations which require the use of appropriate precautions, and does not purport to address all of the safety-related matters associated with its use. It is the responsibility of the user of this standard to establish the appropriate safety practices and determine the applicability of regulatory limitations prior to use.*

4.6.2 Assumptions

- 4.6.2.1 The objective of this test is to ensure adequate friction between shipping containers is achieved so as to produce a coefficient of friction value of between **0.80** and **0.92**, required to create a stable pallet, assuming that the pallet consists entirely of shipping containers of the same brand.
- 4.6.2.2 The CoF depends on environmental conditions. It is assumed that testing is conducted at standard room temperature (between 20° and 25° C) and a relative humidity ranging between 45% and 55%.
- 4.6.2.3 All testing is conducted on a horizontal surface.

4.6.3 Terminology and Definitions

- 4.6.3.1 **Friction:** the resistance an object encounters in moving over another object or surface.
- 4.6.3.2 **Coefficient of Friction:** is a constant value which describes the ratio of the force of friction between two objects and the force pressing them together.
- 4.6.3.3 **Limiting:** when the friction force is at its maximum possible value, friction is said to be limiting.
- 4.6.3.4 **Limiting Equilibrium:** when friction is limiting and the object in question is still stationary.
- 4.6.3.5 **Static Coefficient:** is the ratio of force resisting initial motion of the surface to the normal force.
The static coefficient of friction (μ) between two solid surfaces is calculated as the ratio of the force (Fr) required to initiate sliding between the two surfaces divided by the perpendicular or normal force (Fn) where the normal force (Fn) equals mass of the object multiplied by gravity; $\mu = Fr \div Fn$.
- 4.6.3.6 **Kinetic (dynamic) coefficient:** is the ratio of the force resisting motion of the surface to the normal force once the motion is in progress.
- 4.6.3.7 **Friction Law:** the Friction Law applies to sliding one object along the surface of another. It is the most common form of friction. This law states that the force required (Fr) to overcome friction for two objects or materials pushing against each other equals the coefficient friction (μ) for the two materials multiplied by the perpendicular or normal force (Fn) pushing the objects together; $Fr = \mu \times Fn$.
- 4.6.3.8 **Horizontal Force:** for a horizontal surface the horizontal force required to move a solid resting on a flat surface is the static coefficient of friction (μ) multiplied by the normal force (Fn).

4.6.4 **Apparatus** (refer to Diagram 3, below)

- Work bench
- Fixed brace and clamp mechanism to secure bottom carton (carton #1)
- Block and tackle device to apply horizontal force
- Scale to weigh the top carton (carton #2)
- Scale to measure the applied force

4.6.5 **Diagram 3 – Schematic of Test Method**

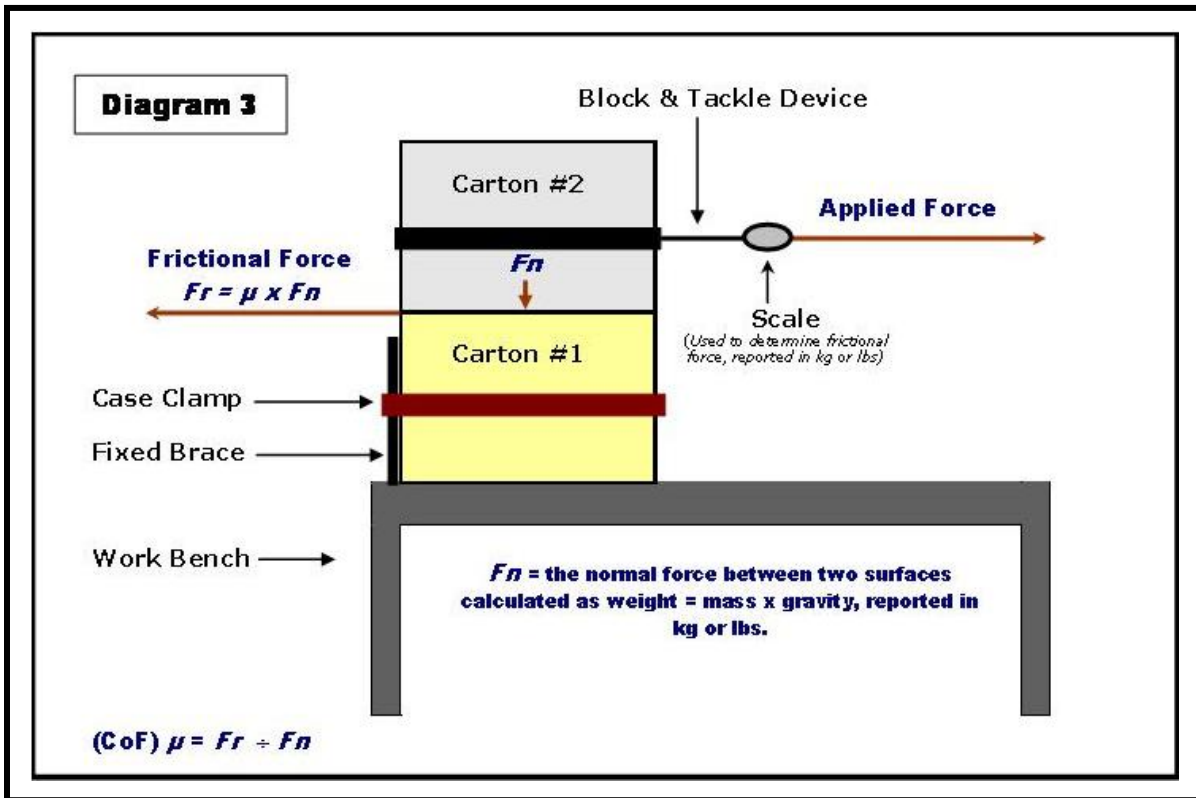

Where: F_r is the resistive force of friction, μ is the coefficient of friction and F_n is the normal force pushing the two objects together. F_r and F_n are measured in units of weight expressed in kg or lbs.

4.6.6 **Preparation**

- Obtain an adequate number of cartons of the same brand to conduct seven (7) pull tests
- Ensure sample cartons to be tested have been conditioned to standard room temperature and relative humidity for a minimum of 48 hours (see 4.6.2.2).
- Ensure scales are calibrated prior to use (see 4.6.7).

4.6.7 **Scale Calibration**

- Calibrate scales following the manufacturer's directions.
- If any weights are outside of their specified tolerances, determine the impact of the variation. If the validation data indicates that the scale performance is inadequate, take the scale out of service until it has been recalibrated and certified by a qualified technician.

4.6.8 **Procedure**

- Determine the value of the normal force (F_n) by weighing carton #2. Note: F_n must be reported in the same units of force (*Newton, kPa or p.s.i.*) as used to report F_r .
- Place carton #1 directly onto the surface of the work bench and secure it to the fixed brace using a clamp device or strap.
- If an anti-skid coating or adhesive is to be used apply it to the top surface of carton #1 following the manufacturer's directions.
- Place carton #2 into position directly on top of carton #1.
- Fasten the block and tackle to the carton #2.
- Secure the pull scale into position.
- Gradually apply force in a manner as to pull carton #2 along the surface of carton #1.
- Record the maximum applied force (F_r), in *Newton, kPa or p.s.i.*, achieved at the time carton #2 begins to move.
- Repeat procedure until seven (7) sets of test results are collected.
- It is recommended not to retest the same cartons, particularly if an anti-skid coating or adhesive is used.

4.6.9 **Calculation and Reporting of Results**

- Calculate and record the CoF (μ) for each test result, $\mu = F_r \div F_n$.
- Eliminate any obvious outliers.
- Calculate the standard deviation of the seven (7) CoF values.
- Calculate and report the mean of the remaining CoF values.

4.6.10 **Conversion Table for Units of Measure**

Unit of Measure	Metric	Imperial
Gravity (G)	$G = 9.8 \text{ m/s}^2$	$G = 32.2 \text{ ft/s}^2$
Newton (N)	$1 \text{ kg} \times 9.8 \text{ m/s}^2 = 9.8 \text{ N}$	$1 \text{ lbs} \times 32.2 \text{ ft/s}^2 = 32.2 \text{ N}$
Kilopascal (kPa)	–	$1 \text{ kPa} = 6.895 \text{ p.s.i.}$
Pounds per Square Inch (p.s.i.)	$1 \text{ p.s.i.} = 0.145 \text{ kPa}$	–
Kilogram (kg)	–	$1 \text{ kg} = 2.205 \text{ lbs}$
Pound (lbs)	$1 \text{ lbs} = 0.454 \text{ kg}$	–

5. CONSUMER UNIT LABELLING REQUIREMENTS

General Information

Allergen Alert

Nutritional Labelling and Claims

**Gift Basket, Ornamental Containers, Accessory Items
and Other Labelling Requirements**

Definitions

Product Date Coding

LCBO Number (formerly CSPC)

U.P.C./EAN on Consumer Unit

Placement of U.P.C./EAN on Consumer Unit

5. CONSUMER UNIT LABELLING REQUIREMENTS

5.1 General Information

5.1.1 The minimum labelling information required for beverage alcohol products is summarized in Chart 9, however, depending on the type of product, additional information may be required. The information, contained herein, is provided as a guide only and does not supersede labelling requirements as specified in the following documents:

- the Canadian Food and Drugs Act and Regulations
- the Canadian Consumer Packaging and Labelling Act and Regulations
- the CFIA Guide to Food Labelling and Advertising
- the Ontario Liquor License Act

5.1.2 Single Field of Vision – the Common Name, Net Quantity, Alcoholic Strength and Country of Origin must appear in a single field of vision (not to appear on the top or bottom of the consumer unit).

5.1.3 All labelling information should be orientated so that the print is horizontal to the top and bottom of the label. Information may be positioned vertically provided it is bold and legible.

CHART 9 – CONSUMER UNIT LABELLING REQUIREMENTS FOR BEVERAGE ALCOHOL

Common Name, Net Quantity, Alcoholic Strength and Country of Origin MUST APPEAR IN A SINGLE FIELD OF VISION (not to appear on the bottom of the consumer unit)

INFORMATION (DECLARATION)	DEFINITION	LANGUAGE	LOCATION	MINIMUM HEIGHT (OF LETTERS)	REQUIRED ON LABEL OF
Common Name As prescribed in Division 2 of the Food and Drug Regulation.	Description of the product type, e.g., wine/vin.	English and French	Single Field of Vision	1.6 mm based on the lower case “o”.	All beverage alcohol products.
Net Quantity (Note: Wine containers are subject to specific sizes as stated in the Consumer Packaging and Labelling Act)	Metric Units of Volume expressed to three (3) significant figures.	English and French, e.g., less than 1 litre: express in millilitres or mL/ml/ml/ 1 litre or more: express in litres or L/l/l/ Note: Abbreviated symbols are bilingual.	Single Field of Vision	Symbol Portion: 1.6 mm based on the lower case “m”. Numerical Portion: see details in Chart 9	All beverage alcohol products.
Alcoholic Strength	Declaration of alcoholic strength: abbreviated: ___% <i>alc./vol.</i> or <i>alc.</i> ___% <i>vol.</i> English: ___% <i>alcohol by volume.</i> French: ___ <i>d' alcool en volume.</i>	English and French The abbreviated format is bilingual. Note: %alc. by vol. is not bilingual.	Single Field of Vision	1.6 mm based on the lower case “o”.	All beverage alcohol products containing 1.1% or more alcohol by volume.

Single Field of Vision – the Common Name, Net Quantity, Alcoholic Strength and Country of Origin **MUST APPEAR IN A SINGLE FIELD OF VISION** (not to appear on the top or bottom of the consumer unit). **Note:** Chart 9 is continued on next page.

CHART 9 - CONSUMER UNIT LABELLING REQUIREMENTS (cont'd)

INFORMATION (DECLARATION)	DEFINITION	LANGUAGE	LOCATION	MINIMUM HEIGHT (OF LETTERS)	REQUIRED ON LABEL OF
Country of Origin	Name of the country where the product originates.	English and French Note: The format <i>Product of/Produit de (du)</i> is acceptable.	Single Field of Vision	1.6 mm based on the lower case "o".	All wines and standardized wine products. All brandies, except Cognac and Armagnac, not produced entirely in Canada.
<p>The term "Cellared in" ("International Blend of") is considered a replacement for the country of origin declaration. Options for "Cellared in" labels include:</p> <p>1) Cellared by (winery name, city, province, Canada) from *imported and domestic grapes (or wines) / <i>Élaboré par</i> (winery name, city, province, Canada) à partir de raisins (ou vins) importés et locaux</p> <p>2) Cellared in Canada from *imported and domestic wines (provided the complete name and address of the manufacturer appears elsewhere on the label) / <i>Élaboré au Canada</i> à partir de vins importés et locaux</p> <p>3) Cellared in Canada from *imported and domestic grapes / <i>Élaboré au Canada</i> à partir de raisins importés et locaux</p> <p>4) Cellared in Canada from *imported and domestic grape juices / <i>Élaboré au Canada</i> à partir de jus de raisins importés et locaux</p> <p>* in descending order of proportion</p>					
Dealer	The identity and principal place of business of the person by or for whom the pre-packaged product was manufactured or produced for sale.	English or French	Anywhere except on the bottom of the package.	1.6 mm based on the lower case "o", clearly and prominently displayed, readily discernible.	All beverage alcohol products.
<p>1) For products manufactured in Canada: show the legal company name of the dealer along with either:</p> <ul style="list-style-type: none"> • the city or town and province; or • the city or town and "Canada". <p>Note: The postal code is encouraged.</p> <p>2) For Imported products: show the legal company name of the dealer along with the city or town and country. US products may use city or town with state and zip in place of city or town and country.</p> <p>Note 1: Where a <u>pre-packaged</u> product that is wholly manufactured or produced in a country other than Canada has applied to it, whether in Canada or elsewhere, a label that shows the identity and principal place of business of the person in Canada for whom the product was manufactured or produced for resale, the identity and principal place of business of that person shall be preceded by the words "imported by" ("importé par") or "imported for" ("importé pour"), as the case may be, unless the geographic origin of the product is stated on the label.</p> <p>Note 2: Where a product that is wholly manufactured or produced in a country other than <u>Canada is packaged in Canada</u> at other than the retail level of trade and the resulting pre-packaged product has applied to it a label that shows the identity and principal place of business of either the person in Canada by whom the product was manufactured or produced for resale in pre-packaged form or for whom the pre-packaged product was manufactured or produced for resale, the identity and principal place of business of that person shall be preceded by the words "imported by" ("importé par") or "imported for" ("importé pour"), as the case may be, unless the geographic origin of the product is stated on the label.</p> <p>Note 3: The statement of geographic origin referred in Notes 1 and 2 shall be located immediately adjacent to the declaration of dealer identity and principal place of business and shall be shown in letters at least as large as those used in the declaration of the Canadian dealer's principal place of business.</p>					
Brewing Location	A declaration of the city / town / place where the beer was brewed.	English	Anywhere except the bottom of the package	1.6 mm based on the lower case "o".	The container of all beers.

Note: Chart 9 is continued on next page.

CHART 9 - CONSUMER UNIT LABELLING REQUIREMENTS (cont'd)

INFORMATION (DECLARATION)	DEFINITION	LANGUAGE	LOCATION	MINIMUM HEIGHT (OF LETTERS)	REQUIRED ON LABEL OF
Declaration of Ingredients	A list of ingredients & components appearing in descending order of proportion by weight.	English and French	Anywhere except on the bottom of the package.	1.6 mm based on the lower case "o".	All non-standardized products.
Allergen Alert	A statement such as "contains (name the allergen)" or "may contain (name the allergen)" to indicate a product may contain one or more of the allergens listed in 5.2.3.	English and French	Non-Standardized Products: immediately following the list of ingredients. Standardized Products: Anywhere except on the bottom of the package.	1.6 mm based on the lower case "o".	All products where allergens are present. Full compliance takes affect Aug. 4, 2012.
Product Date Coding	Production date, best before or freshness date or durable life date.	English	See 6.3.	1.6 mm based on the lower case "o".	All beer and Bag-In-Box and Tetra Pack products and all products with a durable life date ⁵ of 90 days or less.
	See Product Date Coding specifications.				
Return for Refund	Not mandatory in Ontario. If used, a refund statement must contain a disclaimer, e.g., "where applicable" or "where required by law".	English and French	Anywhere except on the bottom of the package.	Disclaimer same size as "return for refund"	Optional at supplier's discretion.
LCBO #	Internal 6 digit control number.	The LCBO Number is NOT to appear on consumer units. This is an internal control number that replaces the CSPC Number (Canadian Standard Product Code).			
U.P.C./EAN BAR CODE		See U.P.C./EAN Specifications.			

⁵ Refer to Part B, Division 1 of the Food and Drug Regulations for compositional standards.

5.2 Allergen Alert

5.2.1 Declaration of allergens on food labels is increasing throughout the world.

5.2.2 Health Canada has developed new regulations for the labelling of allergens in food and beverages. These regulations were registered February 4, 2011 and came into full force on August 4, 2012.

5.2.3 An allergen declaration is required for the presence of the following:

- Peanuts
- Tree nuts (almonds, Brazil nuts, cashews, hazelnuts {filberts}, macadamia nuts, pecans, pine nuts, pistachio nuts and walnuts)
- Sesame seeds
- Milk and derivatives (and fining agents derived from these)
- Eggs (and fining agents derived from these)
- Fish, crustaceans (e.g., crab, crayfish, lobster, shrimp), (and fining agents derived from these)
- Shellfish (e.g., clams, mussels, oysters, scallops)
- Soybeans
- Wheat or triticale
- Sulphites
- Gluten
- Mustard seeds

- 5.2.4 Regulations in the *Consumer Packaging and Labelling Act* require that all non-standardized beverage alcohol products be labelled with a complete list of ingredients, including components (ingredients of ingredients). Some examples of non-standardized products are sake, pernod, aquavit, miscellaneous liquors, etc.
- 5.2.5 Standardized alcoholic beverages listed in Division 2 of the *Food and Drugs Act & Regulations* (FDA) currently do not require a list of ingredients on product labels. A few examples of standardized products are gin, vodka, brandy, wine, etc. To reference FDA regulations, visit the Health Canada website located at: <http://www.hc-sc.gc.ca/>. However, a separate bilingual allergen statement will be required on these products if any of the allergens in 5.2.3, including those used as fining agents, are present.
- 5.2.6 The standard format for an allergen declaration is “contains (name of allergen)”, “contient (nom de allergen)”. A “may contain” statement is only allowed under situations where cross contamination may occur. Products with an ingredient list may use the ingredient list to declare the presence of an allergen.

5.3 Nutritional Labelling and Claims

- 5.3.1 Nutrition facts tables are not required on beverage alcohol products unless claims are made concerning calorie content, carbohydrate content or any other nutritional content.
- 5.3.2 Nutrition facts tables are required on most other food items, e.g. mixes, olive oil, vinegar, etc.
- 5.3.3 See the Canadian Food Inspection Agency Guide to Food Labelling and Advertising for guidance on nutrition facts tables.
- 5.3.4 Claims on labels must meet all applicable regulations and guidelines. Examples of claims include “natural”, “pure”, etc. Claims for organic products must meet the requirements of the Canadian Organic Standard. Further information on claims can be found on the CFIA website.

5.4 Gift Basket, Ornamental Containers, Accessory Items and Other Labelling Requirements

- 5.4.1 Specific labelling requirements may be necessary depending on how products are packaged and sold. It is best to check with a Canadian Food Inspection Agency (CFIA) Food Specialist to ensure all mandatory requirements are met. In Ontario:

Canadian Food Inspection Agency
Manufactured Food Program
1124, Finch Avenue West, Unit 2
Downsview, Ontario
M3J 2E2

Fax: (416) 665-5069
Phone: (416) 667-4698, or 1-800-667-2657

The requirements for the *numerical portion* in *the declaration of net quantity* are outlined in Chart 10.

CHART 10 - DISPLAY SURFACE

DISPLAY SURFACE OF CONTAINER	MINIMUM HEIGHT* OF NUMERICAL CHARACTERS	TYPE FACE	EXAMPLES OF CONTAINER TYPES AND SIZES (Applies To Most Standardized Containers)
Not more that 32 square cm (5 square inches).	1.6 mm (1/16")	Bold	50 mL miniature bottles.
More that 32 square cm (5 square inches), but not more than 258 square cm (40 square inches).	3.2 mm (1/8")	Bold	All Bottles/Cans larger than 50 mL, but smaller than 1.75 L and all 1L Tetra Pak packages.
More than 258 square cm (40 square inches), but not more than 645 square cm (100 square inches).	6.4 mm (1/4")	Bold	All Bottles/Cans 1.75 L or larger, but smaller than 5 L, all Gift Cartons and all Bag-in-Box products 3 to 4 L, but not larger than 4 L.
More than 645 square cm (100 square inches) but not more than 25.8 square decimetres (400 square inches).	9.5 mm (3/8")	Bold	All Bag-in-Box products larger than 4 L.
More than 25.8 square decimetres (400 square inches).	12.7 mm (1/2")	Bold	

Note: Also see definitions on next page.

5.5 Definitions

5.5.1 Dealer:

- means a person who is a retailer, manufacturer, processor or producer of a product, or a person who is engaged in the business of importing, packing or selling any product.

5.5.2 Container:

- means a receptacle, package, wrapper or confining band in which a product is offered for sale, and includes decorative gift boxes, gift packages and tubes, but does not include package liners or shipping containers or any outer wrapping or box that is not customarily displayed to the consumer.

5.5.3 Ornamental Container:

- means a container that, except on the bottom, does not have any promotional or advertising material thereon, other than a trade mark or common name and that, because of any design appearing on its surface or because of its shape or texture, appears to be a decorative ornament and is sold as a decorative ornament in addition to being sold as the container of a product.

5.5.4 Height of a Letter:

- when words appear in upper case, the height of an upper case letter must be based on the upper case letter "O".
- when words appear in lower case, the height of a lower case letter must be based on the lower case letter "o".
- when words appear in both upper and lower case letters, the height of the letters must be based on the lower case "o".

5.5.5 Single Field of Vision

- Key label information must be in a "Single Field of Vision," for all beverage alcohol products. This means all label information must be clearly visible, in the required formats, sizes and languages, on any panel of the "container" except top or bottom, in such a manner that all information appears in a single field of vision.

5.5.6 Size of Display Surface for Single Field of Vision:

(i) Bottles/Cans:

- Where a container does not have a particular side or surface that is displayed or visible under normal or customary conditions of sale or use, the calculated display surface shall be 40% of the total surface area of the container, excluding the top and bottom, if any, if such 40% can be displayed or visible under normal or customary conditions of sale or use.

5.7 LCBO Number (Formerly CSPC)

- 5.7.1 The Canadian Standard Product Code (CSPC) is now obsolete.
- 5.7.2 The LCBO Number **is not to appear** on consumer units.
- 5.7.3 The LCBO Number is strictly for internal use only.
- 5.7.4 Corrective action will be required if an incorrect LCBO # appears on consumer unit. Suppliers will be responsible to cover all costs for corrective action taken by the LCBO.
- 5.7.5 The LCBO recognizes the fact that other liquor jurisdictions may continue to require suppliers to print CSPC Numbers on consumer units, however this practice is **not permitted** in Ontario.

5.8 U.P.C./EAN on Consumer Unit

- 5.8.1 The LCBO requires a Universal Product Code (U.P.C.) or International Article Number (EAN) on all consumer units (selling units).

Note: Each U.P.C./EAN must be assigned a unique Shipping Container Code (SCC-14). Additionally, a U.P.C./EAN may not be assigned to more than one LCBO Number, except value-added items.

- 5.8.2 The U.P.C./EAN information contained in this document is provided as a guide. Readers are encouraged to consult the Canadian Association of Liquor Jurisdictions (CALJ), *Product Identification Standards for Use in the Distribution of Beverage Alcohol*. The CALJ standard provides more comprehensive information relating to U.P.C./EAN requirements for consumer units, shipping containers and serial shipping containers. Copies are available from the LCBO's Sales & Marketing Division or on-line at <http://www.doingbusinesswithlcbo.com/>.
- 5.8.3 Additional U.P.C./EAN bar coding information is available from the Electronic Commerce Council of Canada (ECCC), Don Mills, Ontario; the Uniform Code Council (UCC), Dayton, Ohio, USA; or, from a local International Article Numbering Association (EAN) Office.

Standards for Scannability

- 5.8.4 All U.P.C./EAN bar code symbols on consumer units must meet the applicable standards for quality established by the Electronic Commerce Council of Canada, the Uniform Code Council Inc. (USA), or the International Article Numbering Association (EAN).
- 5.8.5 Based on a sample of 100 selling units, using a flat bed or presentation scanner at a Point Of Sale checkout, 95% of the units must scan on the first pass and all selling units must scan in 2 passes.
- 5.8.6 Symbol quality should be measured with an approved verifier using the test procedures defined by the Electronic Commerce Council of Canada and the Uniform Code Council. The minimum acceptable ANSI test scores are:

Bar Code	ANSI RATING*		Aperture Size
	Numeric	Alpha	
U.P.C./EAN	1.5	C	6 mils

* Based on a verifier using light with a wavelength of 670nm ± 10nm.

- 5.8.7 The procedure for testing is described in either the ECCC or UCC, *Quality Specification for U.P.C. Printed Symbol* manuals.
- 5.8.8 For more detailed information regarding ANSI, refer to Appendix "A".

Acceptable Formats

- 5.8.9 The LCBO will accept:
 - the North American U.P.C. 8 and 12 digit formats, Version E and A respectively; or
 - the International EAN 8 and 13 digit formats.

Symbol Format

5.8.10 The U.P.C. is a 12-digit numeric machine-readable code that identifies a consumer unit. The code consists of a single digit number system character, a 5-digit manufacturer number, a 5-digit item code number and a check digit. All 12 digits must be shown in human readable form below the bar code. The 12 digits are assigned and structured as follows:

- **Number System Character** - assigned by the local code council, e.g., Electronic Commerce Council of Canada, Uniform Code Council or International Article Numbering Association
- **Manufacturer Number** - assigned by the local code council, e.g., Electronic Commerce Council of Canada, Uniform Code Council, or International Article Numbering Association
- **Item Code Number** - assigned and controlled by the manufacturer
- **Check Digit** - calculated using a specific mathematical formula based on the previous eleven digits (12 for EAN), to ensure accuracy of the encoded information. Refer to the *CALJ Product Identification Standards for Use in the Distribution of Beverage Alcohol* for an explanation of the formula used to calculate check digits.

5.8.11 EAN codes are similar in structure, but have 1 additional digit encoded in the Number System Character.

5.8.12 Examples of a U.P.C. and an EAN-13 are shown below:

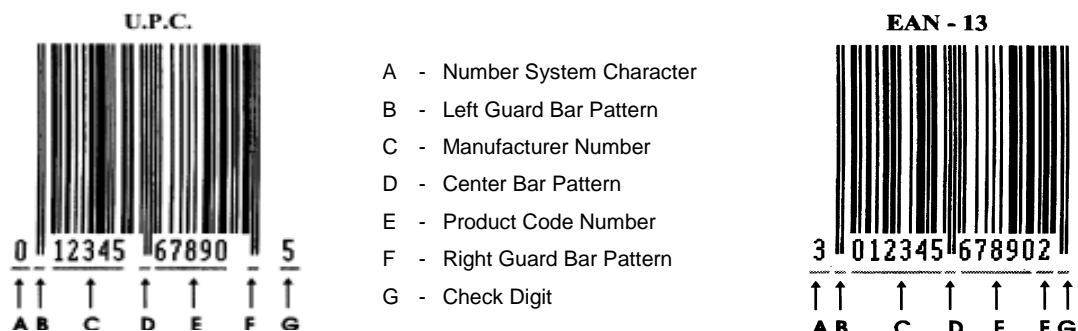

The human readable characters are shown directly beneath the bar code. It is imperative that these characters match the encoded information.

Note: For technical specifications, refer to the *CALJ Product Identification Standards for Use in the Distribution of Beverage Alcohol*.

Symbol Size, Location and Orientation

5.8.13 For technical specifications concerning bar code size, location and orientation, refer to the *CALJ Product Identification Standards for Use in the Distribution of Beverage Alcohol*.

5.9 Placement of U.P.C./EAN. On Consumer Units

Individual Bottles

5.9.1 There are 5 approved ways to locate U.P.C./EAN symbols on individual bottles. They are:

- on the front label
- on a wrap around front label so that the symbols, while part of the front label, are on the side when the bottle is displayed
- on a back label
- on a separate tag or pressure sensitive sticker firmly attached to the bottle
- on the tamper evident seal of certain types of bottles.

- 5.9.2 In each case, the symbols should be placed as close to the bottom of the bottle as possible.
- 5.9.3 The symbols must not be applied to the actual bottom of a bottle.
- 5.9.4 If the symbols are located on the tamper evident seal, they should be positioned in ladder style (bars are parallel to the bottom of the bottle) to avoid distortion that can occur by wrapping the symbol around the neck.
- 5.9.5 Applying the U.P.C./EAN symbol to a neck label is no longer supported by ECCC and UCC standards due to poor scanning performance. If this is the only location available to the supplier, the LCBO will accept a neck label only if it passes the scanning test described in Section 5.8.4 through 5.8.8, Standards for Scannability.

50 mL Bottles

- 5.9.6 The U.P.C./EAN symbol is required.
- 5.9.7 The U.P.C./EAN symbol should be positioned in ladder style.
- 5.9.8 It may be necessary to truncate the U.P.C./EAN symbol's bar height when a bottle is too small to accommodate the full height of the symbol.
- 5.9.9 Reduction to the minimum magnification (80%) should be considered, particularly if truncation is necessary.
- 5.9.10 Manufacturers may wish to use an 8-digit U.P.C. (Version E) or EAN-8 symbol, if possible, on some of these bottles.

Individual Cans

- 5.9.11 Cans intended for individual sale must have a U.P.C./EAN symbol.
- 5.9.12 The U.P.C./EAN symbol must be located near the bottom of the can away from any welds, beads, or flutes that could cause distortion.
- 5.9.13 Depending on the size of the U.P.C./EAN symbol and the diameter of the can, it may be necessary to position the symbol in a ladder style (bars are parallel to the bottom of the can).

Cans in Hi-Cone Multi-Packs

- 5.9.14 When a selling unit consists of individual cans that are connected by plastic rings, the U.P.C./EAN symbol on the can will be used. Each individual can must be appropriately marked with a U.P.C./EAN symbol. A separate U.P.C./EAN symbol designating the pack is not required.
- 5.9.15 For point of sale purposes, either the individual can or the multi-pack unit can be defined as the consumer unit. The LCBO assigns the U.P.C./EAN to the multi-pack unit and uses an override key to sell individual units (e.g., a single can).

Open Carrier Multi Pack Packages

- 5.9.16 Individual bottles in open carrier packs must have a U.P.C./EAN symbol on them. The symbol is not required on the carrier pack, however, if used it must be different than the U.P.C./EAN assigned to the individual bottles.
- 5.9.17 For point of sale purposes, either the individual bottle or the multi-pack unit can be defined as the consumer unit. The LCBO assigns the U.P.C./EAN to the multi-pack unit and uses an override key to sell individual units (e.g., a single bottle).

Bottles or Cans in Sealed Multi-Pack Packages

- 5.9.18 A closed shipping container that is a consumer unit must have a U.P.C./EAN symbol on the bottom or side to comply with U.P.C. standards.
- 5.9.19 If the consumer unit is also the shipping container, then the U.P.C./EAN symbol must appear in 2 locations. The supplier has the option of marking either the top and bottom or one end panel and an adjacent side panel.
- 5.9.20 Only one U.P.C./EAN symbol is required if the consumer unit contains not more than 8 bottles or cans and the capacity of the bottles or cans is 450 mL or less. The symbol should be placed on the bottom or side of the consumer unit.

5.9.21 Cans and tamper evident bottles may be sold individually and must have a U.P.C./EAN symbol even when sold in a sealed consumer unit. The U.P.C./EAN on the consumer unit must be different than the U.P.C./EAN on the cans or bottles inside it.

5.9.22 Bottles that are not tamper evident cannot be sold individually and do not require U.P.C./EAN symbol. Only the consumer unit must be marked.

Bottles in Permanent Outer Packages

5.9.23 Products that are normally sold as a bottle in a box or other outer package must have the U.P.C./EAN symbol printed on the outer package. The supplier, at their option, may also put the U.P.C./EAN symbol on the bottle. In this case, the bottle should have the same number and symbol as the outer package.

5.9.24 The U.P.C./EAN should be located on the bottom of the outer package. If the construction of the package does not allow the symbol to be placed on the bottom, it should be located on the side near the bottom.

5.9.25 When 2 or more bottles are combined in a permanent outer package or if a bottle is combined with an accessory item to create a new selling unit that will retail at a different price, a U.P.C./EAN symbol must be assigned. Care must be taken to ensure that only the U.P.C./EAN assigned to the selling unit is visible to the scanner.

Bottles in Temporary Outer Packages or Gift Packages

5.9.26 When a product is placed in a temporary outer package, e.g., holiday gift package, and there is **no** price difference, the temporary outer package must carry the same U.P.C./EAN symbol as the product inside. Care must be taken to ensure that only the U.P.C./EAN assigned to the selling unit is visible to the scanner.

Note: The assigned SCC-14 must appear on the shipping containers.

Free Item Packs/Value Add

5.9.27 When a free item is attached to a product, a different LCBO number is assigned; however, the original U.P.C./EAN symbol can and should be used if:

- there is no change in the alcohol strength of the original product
- the cost, including duty and taxes, is the same as the regular product.

Note: A different U.P.C./EAN may not be required if the value add is applied at the retail level by a representative of the manufacturer.

5.9.28 A free item should not have a U.P.C./EAN symbol. If a free item has a U.P.C./EAN symbol, the symbol must be defaced (in a manner which makes it unscannable), obscured, or permanently positioned so that it cannot be scanned at the checkout.

Note: A separate SCC-14 must appear on the shipping containers.

Vintage Dates

5.9.29 Different vintages of the same product may carry the same U.P.C./EAN symbol if it is a general list product.

5.9.30 If there is an intention to market and track the different vintages individually, or if the vintages have different prices, a separate U.P.C./EAN symbol must be used.

5.9.31 Products that are not on the general list require a different U.P.C./EAN symbol for each vintage year.

Note: As some products may not be considered general list in all jurisdictions, it may be necessary to offer the same vintage with 2 different U.P.C./EAN symbols (i.e., one for the jurisdictions who wish to track the vintage year and a different one for jurisdictions who consider the product to be general list). The decision is at the discretion of the supplier, based on the requirements of individual jurisdictions.

Non-beverage Products

5.9.32 Non-beverage alcohol products must be assigned their own U.P.C./EAN symbol. The U.P.C./EAN symbol must conform to the standards for general merchandise and apparel.

Note: LCBO Shipping Container Markings (see Chart 2) apply to non-beverage products.

6. STANDARDS FOR TAMPER-EVIDENT PACKAGING

Intent

Definitions

Kinds of Tampering

Acceptable Types of Tamper-Evident Packaging

6. STANDARDS FOR TAMPER-EVIDENT PACKAGING

6.1 Intent

6.1.1 Liquor Jurisdictions are responsible for the sale of products meeting the requirements of the Food and Drug Act and Regulations and the Consumer Products Packaging Act and Regulations. Products offered for sale in Ontario must be done with the knowledge that there are no known hazards or contaminants in the products. All efforts must be made to ensure that, once products are packaged, seals and tamper-evident packaging are in place for products to be sold.

6.2 Definitions

6.2.1 **Tamper-Evidence:** The degree to which tampering is apparent to the observer.

6.2.2 **Tamper-Resistance:** The degree to which it is difficult to tamper (and repair) without leaving evidence. A tamper-resistant package has an indicator or barrier to entry which, if breached or missing, can (reasonably) be expected to provide visible evidence to consumers that tampering has occurred.

6.3 Kinds of Tampering

6.3.1 **Casual Tampering or Grazing:** This situation may happen in the store. The tamperer wants to taste or smell, or change the price by changing caps. He/she does not intend to do harm.

Note: The current method of tamper-resistant packaging serves well against this form of tampering.

6.3.2 **Malicious, Surreptitious Tampering:** This tampering occurs outside the store, e.g., at home, or in a workshop. The tampered package may be returned to the store shelf. This method damages or destroys significantly the integrity of the product, and/or may cause severe illness or even death.

6.4 Acceptable Types of Tamper-Evident Packaging

6.4.1 All products sold by the LCBO must have effective tamper-evident packaging to ensure product integrity. Chart 11 lists the:

- various types of packaging
- description of tamper-proof closures making the product saleable
- description of closures which have been tampered with and making the product unsaleable.

CHART 12 – TAMPER-EVIDENT CLOSURES

PACKAGING	CLOSURES		
	TYPES	TAMPER-EVIDENT (PRODUCT IS SALEABLE)	TAMPERED WITH (PRODUCT IS UNSALEABLE)
Bottles	Paper Strip-Seals	<p>The seal must:</p> <ul style="list-style-type: none"> • extend below the bottom of the cap on both sides of the cap. • be firmly attached to both the cap and the sides of the bottle's neck. • provide clear evidence of being removed (cannot lift off and be re-applied) <p>Note: In most cases, the seal extends on both sides of the cap, however, sometimes and for aesthetic and functional reasons, it is acceptable that the seal extends below the bottom of the cap on only 1 side.</p>	<p>The seal is missing, torn, or loose.</p> <p>The seal is a peel and stick strip, that leaves clear visible evidence once removed.</p>
	Tamper-Evident Rings with Bridge Seals	<p>The metal or plastic ring is attached just under the cap on the bottle and is designed to break when the cap is removed.</p> <p>Plastic caps with hidden bridge seals require paper strip-seals to make them tamper-evident.</p>	<p>The bridge ring is broken.</p> <p>The strip seal is missing, torn, or loose.</p>

Note: Chart 12 is continued on next page.

CHART 12 (cont'd) - TAMPER-EVIDENT CLOSURES

PACKAGING	CLOSURES		
	TYPES	TAMPER-EVIDENT (PRODUCT IS SALEABLE)	TAMPERED WITH (PRODUCT IS UNSALEABLE)
Bottles	Non-Twist Off Crowns	These are typically found on imported beer products and require the use of an opener to remove. Once removed, the cap is deformed and cannot be put back on the bottle.	The crown cap is deformed.
	Twist-Off Crowns	These are typically found on North American beer products and are removed by twisting the cap or using a bottle opener. Beer products using this type of closure must be sold in a sealed consumer unit or otherwise be made tamper-evident by the application of a tamper evident feature, e.g., foil overwrap, shrinkable seals, paper seals, etc.	The sealed container is opened or torn either through breakage or by accident. The tamper-evident seal is missing or torn or the cap is deformed.
	Shrinkable Seals over the Caps	These seals <ul style="list-style-type: none"> are frequently found on twist-off caps. extends up the neck of the bottle over the bottle cap. must be firmly attached to both the cap and the bottle's neck. 	The seal is missing, loose or torn (enough to allow access to the bottle).
	Foil Overwrap	The foil overwrap <ul style="list-style-type: none"> is frequently found on beer and coolers with twist-off caps. extends up the neck of the bottle over the bottle cap. must be firmly attached to both the cap and the bottle's neck. 	The foil overwrap is missing, loose, or torn (enough to allow access to the bottle).
	Cork Finish	Cork finish is used <ul style="list-style-type: none"> mostly in wine but also in some premium spirits, fruit brandies, or liqueurs. together with an over-covering capsule, seal or disc made (normally) of paper, plastic, wax, or metal foil. Note: Paper or wax discs inserted directly on top of corks must adequately adhere to the cork and must provide visible evidence of tampering when removed.	The capsule is absent, or loose and removable. or There is visible evidence that the cork or seal has been tampered with or damaged.
Bag-in-Box (B.I.B)		All B.I.B. products must be winery sealed. The opening in the box for the valve must be sealed.	The opening for the valve in the box has been opened.
Tetra Pak/Flexie Pack (Cheer Pack®)	Tamper- Evident Rings with Bridge Seals	The plastic ring is attached just under the cap on the Tetra Pak and is designed to break when the cap is removed. Plastic caps with hidden bridge seals require paper strip-seals to make them tamper-evident.	The bridge ring is broken. The strip seal is missing, torn, or loose.
	Twist-Off Caps	These are removed by twisting the cap. Tetra Pak products using this type of closure must be sold in a sealed consumer unit or otherwise be made tamper-evident by the application of a tamper evident feature, e.g. plastic pull tab seal.	The sealed container is opened or torn either through breakage or by accident. The tamper-evident seal is missing or torn or the cap is deformed.
Cans	Pull Tabs	The metal pull tab is intact.	The can shows any evidence of having been opened.
	Screw Caps	A metal or plastic ring is attached just under the cap and is designed to break when the cap is removed.	The bridge ring is broken.
Enclosed Packages		Enclosed packages, e.g., beer packages, where the package completely encloses the product and the package seal must be broken to remove a product.	The seal is broken & the enclosed package is open. There is evidence that the package was resealed.
Kegs		Since kegs are (normally) a licensee package under direct control of the Liquor Jurisdiction or Brewery until the delivery of the kegs, the risk of tampering with kegs is minimal. Packaging standards are not set at this time.	N/A

7. QUALITY ASSURANCE GUIDELINES FOR CHEMICAL ANALYSIS

7.1 Chemical Testing Guidelines

Subsequent sections list the chemical requirements. Please note, it is the supplier's responsibility to ensure products conform to compositional standards as specified in the *Canada Food & Drugs Regulations*. As examples, dyes are not permitted in wines or ciders, sorbic acid is not allowed in beer and certain additives and fungicides are not allowed to be used in Canada. LCBO testing does not necessarily cover all compounds specified under the compositional standards.

7.1.1 CHEMICAL GUIDELINE SUMMARY

CHEMICAL NAME (Compound)	MAXIMUM CONCENTRATION ALLOWED				
	Wine	Beer	Cider	Cooler/ Ready-to- Drink	Spirits
Agricultural Chemicals	See section 7.1.2.				
Arsenic (µg/L)	100	100	100	100	100
Cadmium (µg/L)	20	20	20	20	20
	Cadmium leached from glazed ceramics and glassware (small hollowware) in 4% acetic acid: 0.5 mg/L				
Cobalt (µg/L)	20	20	20	20	20
Copper (mg/L)	1.0	Not Tested	Not Tested	Not Tested	Not Tested
Diethylene Glycol (mg/L)	10	10	10	10	10
Dyes	See section 7.1.3.				
Ethyl Alcohol - Actual versus Label Declaration (% alcohol/volume) <i>For non-standardized products, ± 0.5%</i>	± 1.0 for table wines ± 0.5 for fortified wines	± 0.5 if less than 5.6% alc., or ± 1.0 if 5.6% alc. or greater	± 0.5 if less than 5.6% alc., or ± 1.0 between 5.6 and 13.0% alc. <i>Cider alc. range: 2.5 to 13.0 % alc.</i>	± 0.5	± 0.3 ± 1.5 for spirits containing macerated/parts of fruit or plants
Ethyl Carbamate (µg/L) <i>(see exceptions 7.1.6)</i>	30 (Table Wine) 100 (Fortified) 30 (Sake)	15 (Regular) 30 (Extra Strong) (>8.5% alc./vol.)	30	15 100 (dairy based coolers)	150 (Spirits) 400 (Fruit Spirit)
Lead (µg/L)	200	200	200	200	200
	Lead leached from glazed ceramics and glassware (small hollowware) in 4% acetic acid: 2.0 mg/L				
Methyl Alcohol (mg/L)	400	400	400	400	6,000
Ochratoxin A (µg/L)	2	2	Not Tested	Not Tested	Not Tested
Sodium (mg/L)	500	500	500	500	Not Tested
Sorbic Acid (mg/L)	200 500 if < 9% alc., or if > 10 g/L sugar, or sold in non-glass container.	Not permitted	200 500 if greater than 10 g/L sugar	500	Not Tested
Sulphur Dioxide, Free (mg/L)	50 70*	15	50 70*	30	Not Tested
Sulphur Dioxide, Total (mg/L) <i>See 7.1.5 for organic wine limits</i>	300 400* * When TRS ≥ 35 g/L	15	300 400* * When TRS ≥ 35 g/L	100	
Total Reducing Sugars (TRS), (g/L)	Icewine: ≥125 g/L Others: No Limit	No Limit	No Limit	No Limit	Vodka, dry gin: <2 g/L, others per FDR
Turbidity (NTU) <i>(see exceptions 7.1.7)</i>	White: 5 Rose: 8 Red: 10	8	4	No Limit	3
Volatile Acidity (VA) expressed as Acetic Acid (g/L) [VA as Sulphuric Acid (g/L) = VA x 0.815]	1.30 (table wines) 1.50 (late harvest) 1.80 (special select late harvest, BA) 2.10 (icewines, TBA)	No limit if organoleptically acceptable	1.30	No limit if organoleptically acceptable	Not Tested
mg/L = parts per million = ppm µg/L = parts per billion = ppb NTU = Nephelometric Turbidity Units					
BA – Botrytis Affected TBA (Totally Botrytis Affected)					

Note: New product samples under consideration for purchase (e.g. submissions) will be accepted only if the measured amount of each chemical compound is less than 85% of the maximum allowable limit shown. Samples with acceptable VA concentrations must still be organoleptically acceptable.

7.1.2 Agricultural Chemicals

CHEMICAL NAME (Compound)	MAXIMUM CONCENTRATION ALLOWED				
	Wine	Beer	Cider	Cooler/ Ready-to- Drink	Spirits
Agricultural Chemicals:					
• Carbaryl (µg/L)	800	800	300	100	Not Tested
• Cypermethrin (µg/L)*	500	500	500	100	Not Tested
• Iprodione (µg/L)	2,000	2,000	2,000	100	Not Tested
• Malathion (µg/L)*	1,000	1,000	1,000	100	Not Tested
• Myclobutanil (µg/L)	1,000	1,000	1000	100	Not Tested
• Procymidone (µg/L)	1,000	1,000	500	100	Not Tested
* under review					
Agricultural Chemicals <u>not</u> listed above.	100 µg/L	100 µg/L	100 µg/L	100 µg/L	Not Tested
Organic products must have no detectable levels of any agricultural chemicals. <i>See further organic requirements below</i>					
µg/L = parts per billion = ppb					

Note: New product samples under consideration for purchase (e.g. submissions) will be accepted only if the measured amount of each chemical compound is less than 85% of the maximum allowable limit shown.

Agro-Chemicals Routinely Tested in Alcoholic Beverages		
Carbaryl (Sevin)	Euparen (Dichlofluanid)	Myclobutanil
Chlorpyrifos-methyl ester	Fenarimol	Parathion
Diazinon	Guthion (Azinphos-methyl)	Phosalone
Dichloran	Imidan (Phosmet)	Procymidone
Dicofol	Iprodione (Rovral)	Triadimefon
Dimethoate	Methiocarb (MesuroI)	Vinclozolin

7.1.3 Synthetic Dyes

Note: According to the Food and Drug Regulations, synthetic dyes are not permitted for use in standardized beverage alcohol products except for Liqueurs.

Group	Dye Name	Maximum Allowable Limit
Group A	Allura Red	300 mg/L
	Amaranth	300 mg/L
	Erythrosine	300 mg/L
	Tartrazine	300 mg/L
	Sunset Yellow FCF	300 mg/L
	Indigotine	300 mg/L
Group B	Fast Green FCF	100 mg/L
	Brilliant Blue FCF	100 mg/L
Group C	Any combination of synthetic dyes named in Group A or B above.	300 mg/L Individual dyes shall not exceed the Maximum Allowable Limit stated for the named dye.

7.1.4 Miscellaneous Compounds

Compound	Typical Products	Maximum Allowable Limit
Coumarin	Bison grass products	100 µg/L
α-Thujone	Absinthe based products	1000 µg/L
Caffeine	Cola-based beverages or products containing caffeine derived from natural sources	30 mg per serving* <i>* Defined as complete contents of single serve items or 75 mL, whichever is greater</i>

7.1.5 Organic Products

Products identified as organic must meet the following minimum chemical requirements:

Sulphur Dioxide (SO₂) levels in Wines as a function of residual sugar level:

Residual Sugar Level	Free SO ₂ , mg/L	Total SO ₂ , mg/L
<50 g/L	30	100
50 – 99 g/L	35	150
>99 g/L	45	250

Other Chemical Parameters (applicable to all beverage alcohol products):

Parameter	Maximum Allowed
Sorbic Acid	Non-detect
Agricultural chemicals	Non-detect
Synthetic dyes	Non-detect

7.1.6 Ethyl Carbamate Exceptions (under review by Health Canada)

- All wines priced greater than \$30.00 per bottle (retail) and in quantities less than 200 cases per year will fall under the maximum guideline of 150 µg/L ethyl carbamate.
- Rare Sherries and other fortified wine products where the price exceeds \$70.00 per case (wholesale) and in quantities less than 200 cases per year will fall under the maximum guideline of 400 µg/L ethyl carbamate.
- “Sake” with at least 14% declared alcohol will fall under the maximum guideline of 200 µg/L ethyl carbamate.
- Pre-shipment or submission samples of all future orders will be tested, and accepted, only if ethyl carbamate reading is below 85% of the guideline.

7.1.7 Turbidity Exceptions

White Wine: A turbidity reading between 6 and 10 NTU is acceptable provided the wine is identified as unfiltered; either on the label or by a written declaration from the winery, and the following conditions are met:

- Actual alcoholic content is 12% by volume or greater; and
- Total reducing sugars are less than 6 g/L
- Fining agents containing allergens listed in section 5.2.3 were not utilized or if utilized the wine has a fining agent allergen warning on the label

Rose Wine: A turbidity reading between 9 and 15 NTU is acceptable provided the wine is identified as unfiltered; either on the label or by a written declaration from the winery, and the following conditions are met:

- Actual alcoholic content is 12% by volume or greater; and the total reducing sugars are less than 6 g/L
- Fining agents containing allergens listed in section 5.2.3 were not utilized or if utilized the wine has a fining agent allergen warning on the label

Red Wine: A turbidity reading between 11 and 25 NTU is acceptable provided the wine is identified as unfiltered; either on the label or by a written declaration from the winery, and the following conditions are met:

- Actual alcoholic content is 13% by volume or greater; and
- Total reducing sugars are less than 6 g/L
- Fining agents containing allergens listed in section 5.2.3 were not utilized or if utilized the wine has a fining agent allergen warning on the label

Turbidity readings for red wine between 26 and 40 NTU are acceptable if all criteria are met for the 11 to 25 NTU level, the wine has no visible sediment and the sample has an acceptable microbiological assessment. The wine shall be considered stable and acceptable if the wine shows no evidence of microbiological activity.

APPENDICES

APPENDIX–A

ANSI Print Quality Guidelines

The American National Standards Institute (ANSI) has developed a guideline for the print quality of bar code symbols (ANSI X3.182). Copies may be obtained from:

American National Standards Institute, Inc.
 11 West 42nd Street, 13th Floor
 New York, NY, USA, 10036
 Tel: (212) 642-4900

The parameters for bar code quality are divided into two categories:

- Visual Issues
- Technical Issues

Visual Issues: are those which can be adequately monitored through close examination of the printed symbol, e.g., size of quiet zone, proper symbol location, overall print quality, etc.

Technical Issues: are those which can only be adequately measured using a bar code verifier to determine such factors as print contrast, bar and space dimensions, and encodation.

The following is a list of eight (8) technical parameters measured by bar code verifiers to determine overall symbol quality:

ANSI X3.182 BAR CODE (Print Quality Guideline)	
Rate as Pass "A" or Fail "F"	Rated "A" through "F"
Decode	Symbol Contrast
Minimum Reflectance	Modulation
Minimum Edge Contrast	Defects
Element Determination	Decodability

Note: Four parameters are rated as a pass "A" or a fail "F" and four are rated "A" through "F".

Decode: this parameter determines if the correct ANSI decode algorithm is being used for the type of bar code symbol. A verifier checks to see if:

- all characters contained within the code are valid, and utilize the correct number of bars and spaces;
- legal “start and stop” characters are used;
- the code contains the correct check digit(s) when specified;
- the code contains inter-character gaps which are below the specified maximum width;
- the code contains legal quiet zones; and
- the code contains the correct number of encoded characters when specified.

Minimum Reflectance: this parameter is the reflectance value of the “lightest” space. It must be equal or greater than two times the reflectance value of the “darkest” bar.

Minimum Edge Contrast: this parameter is the difference in reflectance between any particular space and its adjoining bar. The contrast must be at least 15%.

Element Determination: this parameter is the reflectance level where the verifier can distinguish spaces from bars. It is calculated using the bar code’s highest and lowest reflectance values. If the number of edges and the distance between edges do not match a known symbol, or if there is more than one crossing between adjoining elements, the bar code is considered non-conforming and the verifier will not be able to decode it.

Symbol Contrast: this parameter measures the reflective difference between the “lightest” space (including quiet zones) and the “darkest” bar. The greater the difference the higher the grade.

Modulation: this parameter looks at the bar codes’ overall uniformity and consistency. It measures how well the spaces and bars reflect light back to the verifier by comparing the bar code’s symbol contrast to the edge contrast. The greater the difference, the lower the grade.

Defects: this parameter measures variations in the reflectance values that are caused by voids in the bars or spots in the spaces. These defects can affect the verifiers’ ability to decode the symbol.

Decodability: this parameter is a method of determining print accuracy. It is the percentage of the available tolerance level that has not been consumed by the printing process. The amount of “safe” margin left after any printing errors is the measure of decodability.

Grade Determination

The ANSI grade for a single scan is the lowest grade assigned to each of the 8 parameters, e.g., if 1 scan results in 7 parameters graded "A" and in 1 parameter graded "F", the overall grade for that scan is "F".

ANSI guidelines recommend 10 scans be taken for each symbol. The overall grade is the average of the 10 individual scans. Each alpha rating is assigned a numeric value that is used to calculate the average.

$$A = 4 \quad B = 3 \quad C = 2 \quad D = 1 \quad F = 0 \quad (\text{"E" not used})$$

Example:

$$(7) \text{ "As" plus } (1) \text{ "B" plus } (2) \text{ "Cs" } = 28 + 3 + 4 = 35 \div 10 \text{ scans} = 3.5 \text{ (average)} = \text{"A"}$$

The following scale is used to convert the numeric average to an alpha rating.

A	≤	4.0	and	≥	3.5
B	<	3.5	and	≥	2.5
C	<	2.5	and	≥	1.5
D	<	1.5	and	≥	0.5
F	<	0.5			

APPENDIX–B: Terms and Definitions

TERMS AND DEFINITIONS	
TERMS	DEFINITIONS
Avoirdupois Ounce	The unit of weight in a weighing system in which 16 ounces avoirdupois make a pound.
Bursting Strength	Strength of material expressed in pounds per square inch, as measured by the Mullen tester.
Shipping Container	A transport package.
1) Carton	A rigid shipping container having closed faces and completely enclosing the contents.
2) Tray	A rigid shipping container having both open and closed faces.
Combined Board Thickness	The summation of the thickness of all facings and corrugating mediums.
Corrugated Board	A structure formed from one or more paperboard facings and one or more corrugated mediums used in making corrugated fibreboard boxes and products.
(1) Single-Wall	The structure formed by 1 corrugating medium glued between 2 facings.
(2) Double-Wall	The structure formed by 3 facings and 2 intermediate corrugating mediums.
Corrugating Medium	Paperboard used in forming the fluted portion of the corrugated board, not less than 26 lbs. per 1000 square feet (0.13 kg/m ²).
Dimensions Length	Length: The larger of the 2 dimensions of the open face of the box. Width: The lesser of the 2 dimensions of the open face of the box. Height: The distance between the outermost surfaces of the box measured perpendicular to the length and width.
ECT ¹ (Edge Crush Test)	A laboratory test method used to measure the cross-direction crushing of a sample of corrugated board.
Facing	A form of paperboard used as the flat members of the corrugated fibreboard, not less than 26 lbs. per 1,000 sq. feet (0.13 kg/m ²).
Flute or Corrugation	The waved shaped paperboard medium(s) of a corrugated board, not less than 26 lbs. per 1,000 sq. feet (0.13 kg/m ²).
Folds	Refer to the location where the fibreboard is bent/creased to create side, top bottom and end panels. The folds generally made by scoring or perforating the fibreboard
Glued Firmly	Shipping containers must be firmly glued by a method of adequate strength and quality so that they remain properly assembled during filling, transportation, and storage. Firm gluing is indicated when tearing of the surface fibre indicates the separation of joined areas.
Joint (Manufacturer's)	It is that part of a shipping container where the ends of the sheet are joined together by taping, stitching, or gluing.
Liner	A creased fibreboard sheet inserted in a container and covering all sides.
Pad	A corrugated or solid fibreboard sheet or other authorized material; it is used for extra protection or for separating tiers or layers of articles within a shipping container when packed for shipment.
Partition	A set of corrugated or solid fibreboard pieces slotted so that they interlock when assembled to form a number of cells into which articles may be placed for shipment.
Perforations	Cuts or notches in the fibreboard used to form folds.
Ply	Any of several layers of solid fibreboard.
Shell	A sheet of corrugated or solid fibreboard scored and folded to form a joined or un-joined tube open at both ends.
Solid Fibreboard	A solid board made by laminating two or more plies of containerboard together.
Water Resistant Adhesive	To be water resistant, the adhesive shall not dissolve in water after the film application has dried.
Water Resistant Board	To be water resistant, the board shall be sized (treated with water-repellent materials) so that the board has a degree of resistance to damage or water deterioration.
Weight of Facings	(Minimum combined weight of corrugated board) It is the summation of weight in pounds per 1000 square feet of all facings in the board structure excluding the weight of coatings and impregnants and excluding the weight of the corrugated medium and the corrugating adhesive.

Note: The terms and definitions shown in this Schedule are from the Railway Association of Canada AC 6000-A, *Railway Packaging Standards* with the exception of the ECT¹ definition.

Summary of Document Revisions – Feb. 21, 2013

Page Number	Article Number	Summary of Revision
	Section 3	<ul style="list-style-type: none"> ○ Updating of Charts 3, 4, 5, 6 and 7 for clarity, cross referencing and acceptable double-wall corrugate flute combinations
27	Section 3	<ul style="list-style-type: none"> ○ Correction to Bottle Partitions references in Chart 8

Past Revisions – Jan. 7, 2013

17-27	Section 3	<ul style="list-style-type: none"> ○ Major revision of section 3 allowing for alternates to burst strength and inclusion of Vintages packaging standards
20	3.4	<ul style="list-style-type: none"> ○ Added text on perforations for hand-holds

Past Revisions – Dec. 5, 2011 (page and article number not valid with current version)

All	All	<ul style="list-style-type: none"> ○ Major revision of numbering to each section and sub-section and removal of references to page numbers where possible
4	0	<ul style="list-style-type: none"> ○ Addition of Introduction section
27-29	4	<ul style="list-style-type: none"> ○ Major revision to intermodal section
31	4.4.6	<ul style="list-style-type: none"> ○ Update on exemptions for USA
36	5.1.1	<ul style="list-style-type: none"> ○ Inclusion of additional references
36	Chart 8	<ul style="list-style-type: none"> ○ Reference to standard wine sizes
38, 39	5.2	<ul style="list-style-type: none"> ○ Major update on allergens with passing of new legislation
39	5.3 and 5.3.4	<ul style="list-style-type: none"> ○ Addition of information on claims
49		<ul style="list-style-type: none"> ○ Added introductory text to chemical guidelines
50		<ul style="list-style-type: none"> ○ Updates to chemical guidelines including alcohol tolerances and organic requirements
52		<ul style="list-style-type: none"> ○ Added specification for Organic products
53		<ul style="list-style-type: none"> ○ Added turbidity exemption for Rose wines; included reference to allergenic fining agents specifications for Organic products

Past Revisions – February 1, 2011

(page and article number not valid with current version)

Page Number	Article Number	Summary of Revision
Pages 27 through 29	2 to 3 inclusive	<p>Major revision to Trailers and Inter-Modal Containers section to reflect LCBO policy change:</p> <ul style="list-style-type: none"> • Loads Shipped In Trailers (Highway Loads) • Loads Shipped in Inter- Modal Containers <ul style="list-style-type: none"> ○ Deliveries to Durham RSC ○ Deliveries to Toronto, London, Ottawa and Thunder Bay RSC's

Past Revisions – June 30, 2010

(page and article number not valid with current version)

Page Number	Article Number	Summary of Revision
Page 2		Update - Reference to Division and Revision Date
Page 13	1.1	Add - <i>A U.P.C./EAN cannot be assigned to more than one SKU (LCBO Item Number), except value-adds.</i>
Page 17	1.6	Revised - Perforations intended to create openings within a shipping container to display or remove product are prohibited. Perforations for the purpose of creating folds (see 1.5) are permitted provided the perforations do not reduce the structural integrity of shipping containers or cause an increase in damage that may occur during normal handling. A non-compliance penalty may be assessed if damage results in packaging failure or breakage.
Page 17	1.7	Revised - maximum case weight updated to 18.9 kg or 41.6 lbs.
Page 19	3.10	Revised - number of bottles permitted in selling updated unit from 8 to 12 to be consistent with 6.6.
Pages 20 & 21	Charts 3, 4 & 5	<p>Column Burst Strength – Updated references from lbs. to p.s.i.</p> <p>Column Maximum Weight – Updated to 41.6 lbs (18.9 kg)</p>
Page 22	8.1 – 8.6	Revised - additional clarification pertaining to LCBO requirements for bottle partitions.
Page 27	1.3	Deleted - Suppliers have the option to use trailers or inter-modal containers.
Page 27 & 28	2.1 – 2.12	Revised - clarification pertaining to LCBO requirements for Continental North American Products shipped on pallets.

June 30, 2010 (cont'd)

Page 28	3.1	Revised - Finished pre-package products originating from countries outside Continental North America shall be shipped in 'bulk' loaded inter-modal containers, in accordance with all requirements detailed in this section.
Page 28	3.3	Revised - Individual Stock Keeping Units (SKU's) must be loaded in a contiguous manner when multiple (SKU's) are loaded within the same container. SKU's must be separated from one another across the width of the container. Placing the same SKU in different locations throughout the container is not permitted. Stacking different SKU's on top of one another is permitted to continue loading the container, from the nose to the rear doors, provided all SKU's are loaded in a contiguous manner across the width of the container (see diagrams 1 and 2).
Page 28	3.5	Deleted - Shrink-wrap is permitted to maintain load stability provided it is not fastened in any way to the container, and provided the shrink-wrap is recyclable.
Page 28	3.6	Revised and Re-numbered to 3.5 - Containers must be loaded up to the face of the container doors. If order quantities do not permit this, the load must be adequately secured to prevent shifting, e.g., stepping down the rows or use of retaining bars, air bags or similar mechanical devices.
Page 28	3.8	Revised and Re-numbered to 3.6 - Shipping Containers must be loaded so that the consumer units packaged inside are orientated in an optimum position to ensure stability. For example, shipping containers with selling units packaged in a vertical position must be loaded so that the selling units are orientated in an upright position and shipping containers with selling units packaged in a horizontal position must be loaded so the selling units remain lying on their sides.
Page 28	New	Note added - Suppliers loading inter-modal containers are solely responsible for ensuring adequate measures are taken to stabilize loads for transit and will be held liable for any damage that occurs during transit.
Page 28	3.9	Deleted - Palletized loads are permitted, provided all requirements set out in Section 2.0 are met.
Page 29	New	Added - Diagrams 1 & 2
Page 30	New	Added – New section: Protective Service
Page 31	New	Added – New section: Pull Force Test Method for Measurement of Static Coefficient of Friction
Page 55	New	Added – Document Revision Summary

Notes
